



Čeština
Dansk
Deutsch
Eesti
Ελληνικά
English
Español
Français
Italiano
Latviski
Lietuviškai
Magyar
Nederlands
Norsk
Polski
Português
Slovenčina
Slovenski
Suomi
Svenska

Leica M Stereo- microscopes

User Manual

Leica
MICROSYSTEMS

Dear User

Thank you for choosing our products. We hope that you will enjoy the quality and performance of Leica Microsystems products.

In developing our instruments, we have placed great emphasis on simple, self-explanatory directions. In order to utilize all the benefits of your new stereomicroscope, we suggest studying this user manual in detail. Should you have any questions, please consult your local Leica representative. You will find the address of the closest local representative as well as valuable information about products and services from Leica Microsystems on our homepage at www.leica-microsystems.com

We are gladly at your service. Customer service is a big thing with us. Not only before the sale, but afterwards as well.

Leica Microsystems (Switzerland) Ltd
Stereo & Macroscopy Systems
www.stereomicroscopy.com

User Manual

Your instrument is accompanied by a printed English user manual. Additional language versions and information can be found on the interactive CD-ROM. User manuals and updates are available for download on our homepage at www.stereomicroscopy.com.

This user manual contains an explanation of the safety regulations, assembly, handling and accessories of the Leica MS5, MZ6, MZ7s, MZ9s, MZ12s, MZ16, MZ16 A and MZ16 FA (if identical) stereomicroscopes. The special functions of the automated stereomicroscopes Leica MZ16 A and MZ16 FA can be found in separate user manuals.

Table of contents

	Page
Overview	
Safety concept	6
Symbols	9
Controls and functions	10
Use	
Changing the magnification	12
Ergonomics	14
Interpupillary distance	15
Eyepoint	15
Eye contact, eyecups	16
Focusing	16
Microscope carrier: Stereoscopic and axial observation	18
Diopter settings	20
Assembly	
Overview: Components	22
Stand	
Profile column for incident light and transmitted-light stands ..	23
Transmitted-light stand, bright field, 20 W	23
Transmitted-light stand, bright and dark field	26
Transmitted-light stand HL	27
Swinging-arm stand ESD	28
Large swinging-arm and table-clamp stands	30
Optics carrier, optical accessories	
Spacer rings, objective combinations	32
Microscope carrier	34
Optics carrier	34
Binocular tubes, optical accessories	35
Objective nosepiece (MZ16 and MZ16 A)	36

	Page
Illuminators	
Transformers	38
Incident lamp 6 V/10 W	40
Incident lamp 6 V/20 W	42
Cold light sources	45
Fiber-optic light guide	46
LED illumination	46
Supply (line) lamp 25 W	47
Coaxial illuminator	47
Near-vertical illuminator	48
 Accessories	
Fitting accessory tubes	50
Double-iris diaphragm	50
Drawing tube, discussion tube	51
Video/phototubes:	
Photography, video, TV, filming, digital imaging	52
Attachment for vertical and oblique observation	56
Graticules	56
Stages, polarization	57
 Special notes	
Tips and hints: What to do if	58
Care and maintenance	59
Calculating total magnification and field of view diameter	61
Optical data for MS5, MZ6	62
Optical data for MZ75, MZ95	64
Optical data for MZ125, MZ16, MZ16 A	66
Dimensions	67
Technical data electrical devices	74

Safety concept

General directions **Read the user manual and safety instructions before starting up.**

Permitted uses The Leica MS5, MZ6, MZ7₅, MZ9₅, MZ12₅, MZ16 and MZ16 A stereomicroscopes are optical instruments which use magnification for improved visualization of objects, their details and specimens from technology and natural sciences. The basic outfit, which includes a stand and a light source, can be supplemented with various modules for photography, TV, dual station viewing and other applications.

Prohibited uses

- The use of the instrument in a different manner from that described in this user manual can lead to injury, malfunction and damage.
- The Leica MS5, MZ6, MZ7₅, MZ9₅, MZ12₅, MZ16 and MZ16 A stereomicroscopes must not be used for eye examinations and operations.
- Do not fit different plugs. Do not dismantle optical systems or mechanical parts unless instructions for doing so are given in the user manual.

Place of use

- The Leica MS5, MZ6, MZ7₅, MZ9₅, MZ12₅, MZ16 and MZ16 A stereomicroscopes are intended mainly for indoor use.
- If the stereomicroscope is used outdoors, protect it from dirt and moisture. Lamps and electrically-operated stands from Leica may not be used outdoors.

Use in ESD protected rooms

The optics carriers MS5, MZ6, MZ7₅, MZ9₅, MZ12₅, MZ16 and MZ16 A, the binocular tube, ErgoTube™, ErgoWedge™ 5°–25°, the swinging-arm stand ESD and the cold light sources Leica L2 and CLS consist of ESD-discharging material (surface resistance <10¹¹ ohms/squared, discharge time <2 seconds, 1,000 V to 100 V).

- A connection socket for a Ø 4 mm grounding cable is provided on the microscope carrier.
- There are two connection sockets for Ø 4 mm grounding cables in the base of the swinging-arm stand.

Use in Clean Rooms

The Leica M series can be used in clean rooms without any problems and they can be cleaned as described on page 60. Please observe the following rules:

- Do not clean our stereomicroscopes and accessories in a different manner from that described in this user manual. Do not use unsuitable cleaning agents, chemicals and techniques. Do not clean painted surfaces and accessories with rubber parts such as the ErgoTube® 10° – 50° with chemicals. This can damage the surfaces. Particles or grindings can contaminate the specimen.
- If the customer cleans our instruments with chemicals without our written approval he will do it at his own risk.
- In most cases we can offer special solutions on request. Some products can be modified or we could recommend other accessories for use in clean rooms.

Safety regulations

Servicing Repairs may only be carried out by Leica-trained service technicians.
Only original Leica spare parts may be used.

Responsibilities of person in charge of instrument

- Ensure that personnel who use the instrument have read and understood this user manual and in particular the safety instructions.
- Ensure that the Leica MS5, MZ6, MZ7_s, MZ9_s, MZ12_s, MZ16 and MZ16 A stereomicroscopes are operated, maintained and repaired only by authorized and trained personnel.



Workplaces with stereomicroscopes facilitate and improve the viewing task, but they also impose high demands on the eyes and holding muscles of the user. Dependent upon the duration of uninterrupted activity, this may lead to asthenic trouble and muscular-skeletal pain so that suitable measures must be taken to reduce the strain:

- perfect design of workplace (see p.14), work content and work process (frequently changing activities).
- detailed introduction of the personnel while considering ergonomic and organizational work-related aspects.

The ergonomic optics concept and the design of the Leica M series aim at limiting the strain on the user to the lowest possible level.



Direct contact with eyepieces can be a potential transmission path for bacterial and viral infections of the eye. Users should be made aware of the potential risk of infection. The risk can be kept at a minimum by using individual eyepieces or attachable eyecups (see p.16).

Electrically-operated items

The safety regulations listed below apply to the following items:

- Transmitted-light stand, bright field, 20 W (page 24)
- Supply (line) lamp 25 W (page 47)
- Regulating transformer 0–7 V/40 W (page 38)
- Step transformer 4/5/6 V (page 39)
- Motor focus (separate instructions)
- Motorized Leica MZ16 A

Liquids Be careful when handling liquids.

If spilt on the equipment, they can:

- cause the stereomicroscopes and accessories to become electrically live, endangering personnel,
- cause damage to the equipment.

Power cables Inspect cables regularly for damage. Defective cables can:

- directly endanger personnel,
- cause the stereomicroscopes and accessories to become electrically live, endangering personnel.

Cable routing Route cables with care. Make sure that personnel do not get entangled with them. The instrument could fall over, fall down, become damaged, damage other equipment, or cause personal injury.

Opening the instrument Only authorized Leica personnel are permitted to repair electrical equipment. Before opening up the equipment, pull out the power cable. If you touch the live interior of the equipment, you may receive an electric shock.

Supply voltage Ensure that the voltage setting on the equipment is correct. A wrong setting can cause damage to the equipment.

Connections When connecting power-consuming devices to the transformers, do not exceed the maximum permitted loading, as this can cause damage to the equipment.

Changing bulbs

- Before changing a bulb, disconnect the power cable.
- Never attempt to touch the inside of a lamp housing or transmitted-light stand while the instrument is connected to the power supply.
- Before changing a bulb, wait until it is cool, otherwise you may burn your fingers.

Integration in third-party products	The following must be observed if Leica products are build into third-party products: The manufacturer of the complete system or the person putting it on the market is responsible for adhering to applicable safety regulations, laws and guidelines.
Legal requirements	Adhere to general and local regulations relating to accident prevention and environmental protection.
Disposal	The products described here must be disposed off in accordance with applicable local laws and regulations.
Conformity with European Community directive	The electrically-operated accessories for the Leica MS5, MZ6, MZ7s, MZ9s, MZ12s, MZ16 and MZ16 A stereomicroscopes are constructed in accordance with the latest technologies and provided with a statement of conformity with EC requirements.

Symbols used in this user manual



Safety instructions

This symbol denotes information which must be read and obeyed. Non-observance

- can put personnel at risk!
- can cause malfunctioning or damage to the equipment.



Warning about accessible hot places, e.g. bulbs.

Failure to respect it can cause burns!



Important information

This symbol denotes additional information or explanations which promote understanding.

Action

- ▶ This symbol within the text indicates that certain operations must be carried out.

Explanatory notes

- This symbol within the text stands for additional information and explanations.

Overview

Stereomicroscope

- 1 Magnification changer**
- 2 Engaging ratchet positions**
- 3a Focusing drive**
- 3b Coarse and fine focusing**
Larger knob: Coarse focusing,
Smaller knob: Fine focusing.
- 3c Adjustable ring**
Changes the ease of movement
of the coarse/fine drive.
- 4 Clamping screw**
Holds the optics carrier in the
microscope carrier.
- 5 Clamping screw**
Holds the binocular tube (or accessory)
to the optics carrier.
- 6 Interchangeable objective**
Achromatic, planachromatic or planapochromatic

Binocular tube

- 7 Adjustable eyepiece tubes**
Interpupillary distance adjustable from
52 mm – 76 mm.
- 8 Wide-field eyepieces for persons wearing
glasses**
Diopter setting adjustable within the range
from +5 to –5, and eyecups adjustable.
- 9 Clamping screws**
These hold the eyepieces in the
binocular tube.
- 10 ErgoTube™**
The viewing angle is adjustable within the
range 10° – 50°.
- 11 Built-in double-iris diaphragm
(MZ16/MZ16 A only)**
 - The special functions of the Leica MZ16 A are
shown in the user manual M2-116-0.

Leica MS5

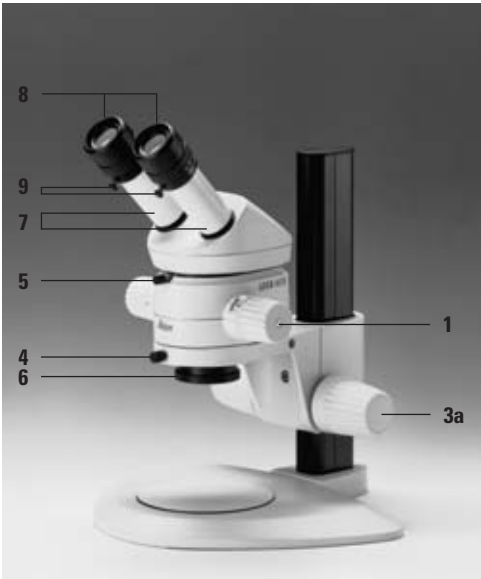

Leica MZ6

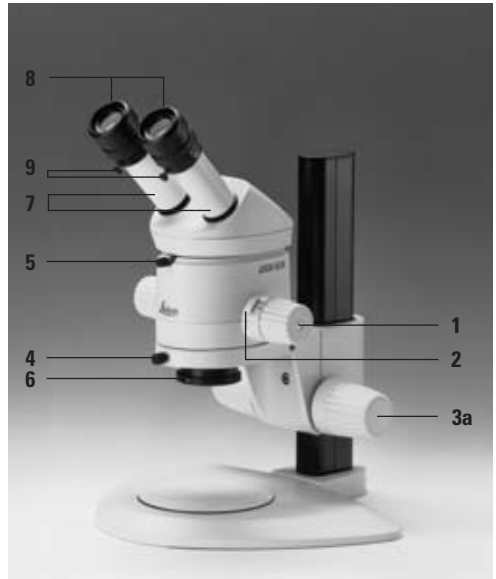

Leica MZ75

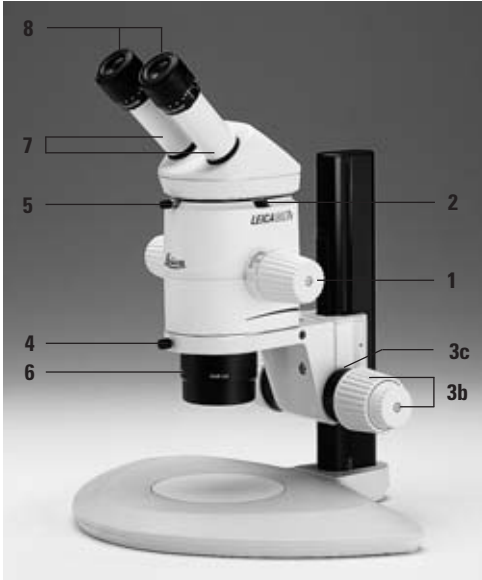

Leica MZ95

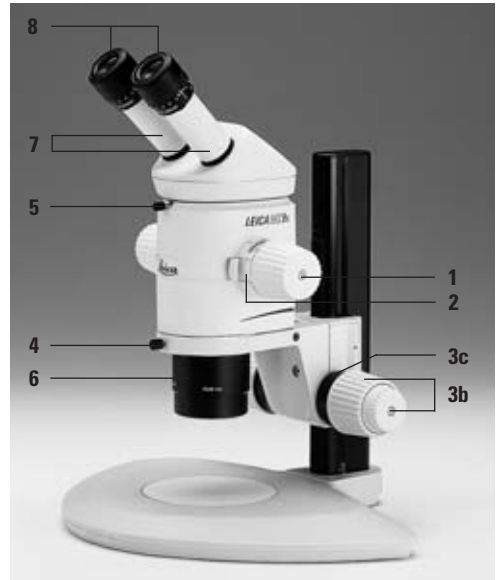

Leica design
by Ernest Igl/Christophe Apothéoz

Leica MZ125



Leica MZ16

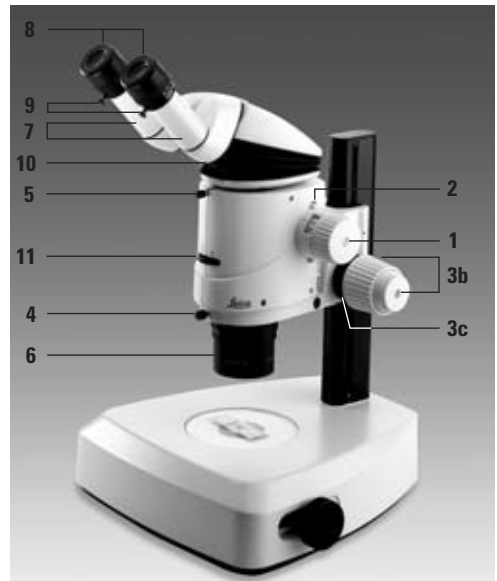

Magnification changer

- Zoom means continuous change of magnification. Ratchets can be engaged for certain magnifications (see below).
- For zooming with MZ16 A, see the user manual M2-116-0.

MS5: 5 steps

MZ6: 6:1 zoom

MZ7_s: 7.9:1 zoom

MZ9_s: 9.5:1 zoom

MZ12_s: 12.5:1 zoom

MZ16 and MZ16 A: 16:1 zoom

Changing the magnification

- The magnification changer can be operated from either the right or the left side.
 - ▶ Look into the eyepieces.
 - ▶ Focus on the object (page 16).
 - ▶ Turn the magnification changer to the desired position.

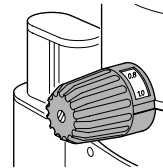

Ratchet steps

MZ6: 0.8, 1, 1.25, 1.6, 2, 2.5, 3.2

MZ7_s: 0.8, 1, 1.25, 1.6, 2, 2.5, 3.2, 4

MZ9_s: 0.8, 1, 1.25, 1.6, 2, 2.5, 3.2, 4, 5

MZ12_s: 1, 1.25, 1.6, 2, 2.5, 3.2, 4, 5, 6.3, 8

MZ16: 0.8, 1, 1.25, 1.6, 2, 2.5, 3.2, 4, 5, 6.3, 8, 10

- Engage the ratchets whenever magnifications need to be exactly reproducible.

- ▶ For MZ6, MZ9_s, MZ12_s and MZ16: Press the switch.

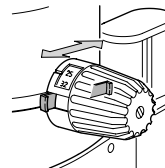

- ▶ For MZ7_s: Turn the knurled ring counterclockwise.

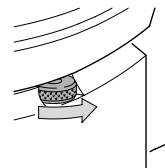

For setting ratchets at the MZ16 A, see the user manual M2-116-0.

Scale of magnifications

MS5, MZ6: Display of magnification factors from 0.63–4.

MZ7₅: Display of magnification factors from 0.63–5. Corresponding scales for other objective and eyepiece combinations can be affixed to the rotary knobs (page 34).

MZ9₅: Display of magnification factors from 0.63–6.

MZ12₅: Display of magnification factors from 0.8–10.

MZ16, MZ16 A: Display of magnification factors from 0.71–11.5

MZ16 A: For the digital display of the magnification see the user manual M2-116-0.

Magnifications and fields of view

The tables on pages 62 – 66 provide information about the magnifications and field of view diameters as a function of the magnification changer position of the eyepiece-objective combination used.

Magnification with MZ12₅/MZ16 planachromatic and planapochromatic objectives

When the MZ12₅/MZ16 planachromatic and planapochromatic objectives are used on the Leica MS5, MZ6, MZ7₅ and MZ9₅, the magnification is increased by the factor 1.25×. This factor is taken into account in the tables.

Magnification on MZ12 ₅ /MZ16	Magnification on MS5/MZ6/MZ7 ₅ /MZ9 ₅
1× plan/planapo	1.25×
1.6× planapo	2×
0.63× planapo	0.8×
0.5× plan	0.63×
0.8× plan	1×
2× planapo	2.5×

Ergonomics, viewing height

Preconditions for working comfortably

- Pay great attention when setting up your stereomicroscope. You will only benefit fully from the outstanding optical and ergonomic advantages of the instrument if you set it up precisely in accordance with the directions already given.
- For fatigue-free work, use the ErgoModules™.
- Arrange your workplace as well as possible, and pay attention to the heights of chair and table.
- When sitting, use the entire seat area and also the back support of the chair.
- Support your forearms.
- During work breaks, stand up and move around for exercise.

Please also observe the note on p. 7.

Ergonomics

The reasons why users often cannot work comfortably with the 45° tube are the differing heights of the outfits, the various accessories and working distances, and the fact that the same instrument is often used by several people of differing builds. This problem can be effectively solved by using the Leica ErgoModules™.

If you have problems with the viewing configuration on your stereomicroscope, ask your Leica consultant for the most ergonomic Leica solutions.

Ergo objective

With the achromatic Ergo objective 0.4×–0.63× for the Leica MS5, MZ6, MZ7_s and MZ9_s it is possible to focus in the region of 90mm (63.5 mm – 153.5 mm) ergonomically and precisely, without changing the viewing height. At the same time, magnification and working distance can be changed without any time-consuming changing of the objectives.

Viewing height, viewing angle

The viewing height is correct when your head and back are comfortably positioned.

- On the ErgoTube™, the viewing angle is adjustable from 10° – 50°.
- ▶ Holding the eyepiece tubes at their bases, swing them up or down (see arrow).

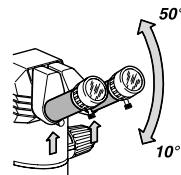

- ErgoModule™**
- ErgoWedge™ 5° – 25°
 - ErgoWedge™ ±15°
 - ErgoModule™ 50 mm
 - The ErgoTube™ 45° has eyepiece tubes which are 65 mm longer than the standard ones.
Magnification factor 1.6×



MZ16 A: The magnification factor can be toggled on and off using the **OPT** key.

- ErgoModule™ 30 – 120 mm
Relubrication may be required after several years (please send the item to Leica Service).

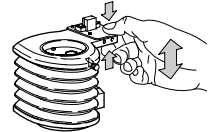

Ergo objective The achromatic Ergo objective 0.4×–0.63× can be used to ergonomically and accurately focus in the range of 90 mm (63.5–153.5 mm) without changing the viewing height. At the same time, magnification and working distance can be changed without time-consuming change of objectives.

Motor focus Frequently repeated fine-motor tasks, such as focusing by hand, can lead to muscle fatigue and hand problems. Using the Leica motor focusing system, every equipment can be moved up and down without applying force.

Interpupillary distance, eye contact

Interpupillary distance

The interpupillary distance is correct when you see a single circular field when viewing with both eyes.

- ▶ Look into the eyepieces and use both hands to move the eyepiece tubes closer together or further apart.

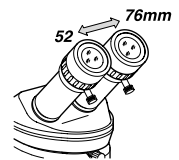

Locating the exit pupil

The distance between eye and eyepiece measures approx. 22 mm for 10×/21B wide-field eyepieces for persons wearing glasses and 12 mm for 10×/21 wide-field eyepieces.

- ▶ Slowly approach the eyepieces with your eyes until you can see the complete image field without corner cutting.

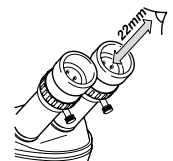

Selecting the degree of eye contact

You do not wear glasses and prefer close contact with 10×/21B wide-field eyepieces for persons wearing glasses:

- ▶ Holding the diopter ring, turn the eyecup counterclockwise until it is released.

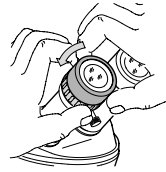

- ▶ Pull the eyecup upwards.
- ▶ Holding the diopter ring, turn the eyecup clockwise.

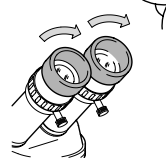

Persons wearing glasses need the whole of the available distance. Move the eyecups to the lowest position.

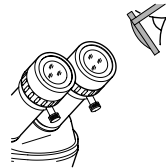

Soft eyecups

The 10×/21B wide-field eyepieces for persons wearing glasses are supplied with soft eyecups, which can be attached to the integrated eyecups made of hard plastic to achieve the following:

- Prevent eye infections if several users are working at the same instrument (see p. 7).
- Protect your glasses from being scratched.

The 10×/21 wide-field eyepieces are supplied with laterally tapered soft eyecups.

Setting the working distance, focusing = obtaining a sharp image

- To focus, use the focusing drive to raise or lower the stereomicroscope until the feature of interest is in focus = working distance to the objective.
The working distances of the various objectives are listed in the tables on pages 62 – 66.
- The focusing drive can be operated from either the right or the left side.
- When focusing on a new object, always start with the lowest magnification, because the larger field of view makes the object easier to find. Afterwards, select the desired magnification.

- ▶ Place the object beneath the objective.

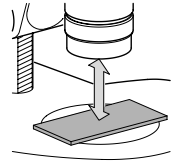

- ▶ Engage the lowest magnification (page 12).
- ▶ Look into the eyepieces.
- ▶ Using the rotary knob, bring the object into focus.

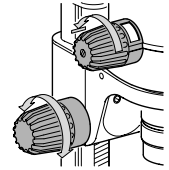

Coarse/fine drive

The coarse/fine drive supports up to 15 kg.

- Resolution with 5 kg load: 1 μm
- Resolution with 10 kg load: 2 μm
- ▶ Focus approximately with the larger knob.
- ▶ Fine-focus with the smaller (concentric) knob.

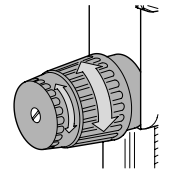

Adjusting the free running of the focusing drive

Is the focus movement too loose or too tight? Does the outfit tend to slide downwards? You can adjust the movement in accordance with the weight of the outfit and with your own personal requirements:

– Focusing drive MS5 – MZ9_s

- ▶ Hold the drive knobs firmly with both hands and turn them in opposite directions until you obtain the required degree of resistance during focusing.

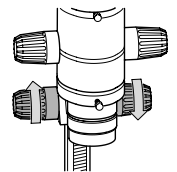

– Focusing drive, coarse/fine

- ▶ Hold the left or right fine drive.
- ▶ Turn the other fine drive until the desired resistance during focusing is reached.

Microscope carrier

Microscope carrier for stereoscopic observation

- This microscope carrier permits only stereoscopic observation, using both beam paths.
- The microscope carrier can be fitted to the drive housing in either of two positions (see page 34):
- The optics carrier can be turned sideways in the microscope carrier if the user needs to work from the side:
 - ▶ Release the clamping screw.
 - ▶ Turn the optics carrier sideways as required.
 - ▶ Retighten the clamping screw.

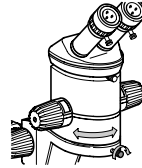

Microscope carrier AX

The stereomicroscopes can be equipped with the microscope carrier AX for stereoscopic and axial observation instead of the standard microscope carrier (page 34).



Different models are available for MS5, MZ6, MZ7₅, MZ9₅ and for MZ12₅, MZ16 and MZ16 A. The achromatic objectives and the planochromatic 1× fit in the thread in the AX microscope carrier for MS5, MZ6, MZ7₅, MZ9₅ (p. 33).

The planochromatic and planapochromatic objectives fit in the thread in the AX microscope carrier for MZ12₅, MZ16, MZ16 A (p. 33). In addition, the AX microscope carrier features a clamping screw for fixing it in one of 3 positions and an aperture which can be turned manually (see below). Otherwise, the use of and switching to the left, middle and right position are identical.

- The optics carrier **cannot** be turned sideways in the microscope carrier AX.

Stereoscopic observation

A three-dimensional image is required for examining plastic objects and for working.

- ▶ Shift the stereomicroscope to the central position.

Axial observation

The parallax-free imaging produces more precise results in photography, measuring and polarization.

- ▶ Shift the stereomicroscope to the left or the right position. The object is now located directly beneath either the left or the right beam path.
- When photographing or measuring, select the beam path above which the phototube or measuring graticule is located.

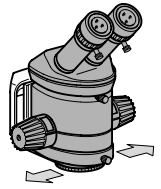

Aperture

A rotating aperture is built into the AX microscope carrier. It prevents interfering reflections during axial observation with coaxial incident illuminator and quarter-wave plate.

- With the AX microscope carrier for MS5, MZ6, MZ7_s, MZ9_s, the aperture automatically turns during the moving process.
- With the AX microscope carrier for MZ12_s, MZ16, MZ16 A, the aperture is located underneath the microscope carrier and must manually be turned as follows:

Please note:



- In the position for stereoscopic observation through both beam paths, turn the aperture counterclockwise until it stops. Otherwise the field of view is underexposed (vignetting).
- In the position for axial observation through the right or left beam path, turn the aperture clockwise until it stops.

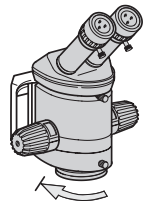
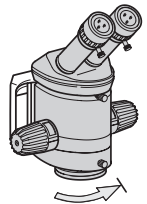

Adjusting diopter settings and parfocality

Tips for your work



Leica stereomicroscopes are parfocally matched. This means that, once you have focused on a feature in the manner described, taking account of diopter settings, you can zoom the magnification up and down without refocusing. You only need to refocus if you want to look at higher or lower planes in the object. A prerequisite is the correct setting of the diopters and the parfocality.

- The dioptic range is from +5 to -5.

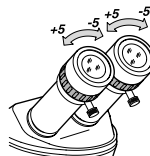

The following adjustments must be carried out only once by each user. The procedures for adjusting the diopter setting and the parfocality are somewhat different if an eyepiece contains a graticule. Refer to the user manuals for the MPS modular photomicrographic systems or for measuring.

A Preparations

- ▶ Install the lamp.
- ▶ Set the interpupillary distance and, if necessary, the viewing height.
- ▶ On the video/phototube: Move the lever to position "VIS" and open the diaphragm.
- ▶ Set the double-iris diaphragm to "OPEN."
- ▶ Adjust the eyecups.
- ▶ Set both eyepieces to zero.
- ▶ Set the microscope carrier AX for stereoscopic observation.

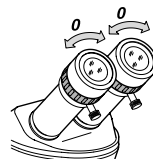

B Focus on the test object

1. Place a flat test object under the objective.

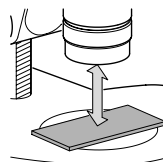

2. Engage the lowest magnification position.

- ▶ Use the coarse focusing drive to set the working distance (page 16).

3. Look into the eyepieces

- ▶ Use the focusing drive, to bring the test object into focus.

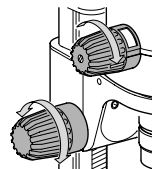

4. Engage the highest magnification position.

5. Optimize the focus using the focusing drive.

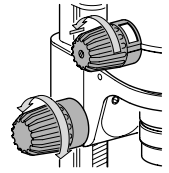

C Adjusting dioptric settings

6. Engage the lowest magnification position.

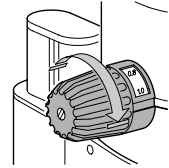

7. Do not look into the eyepieces.

► Rotate the eyepieces counterclockwise in the "+" direction as far as the stop (+5 diopters).



8. Look into the eyepieces

► Slowly rotate each eyepiece individually in the "-" direction until each eye sees the object sharply imaged.

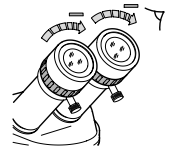

D Inspecting parfocality

9. Engage the highest magnification position.

10. Refocus if necessary.

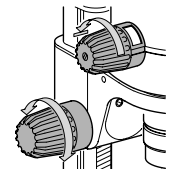

11. Slowly move the magnification changer from the lowest magnification to the highest.

• **The image sharpness must remain constant (parfocal). Otherwise, repeat the procedure.**

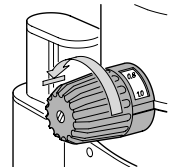

Assembly

The components

- 1a Incident-light base with stage plate
- 1b Transmitted-light base with glass stage plate
- 2a Side-faced column with drive housing, coarse/fine
- 2b Side-faced column with drive housing, 300 mm or 500 mm
- 3 Microscope carrier
- 4 Optics carrier
- 5 Interchangeable objective
- 6 Binocular tube
- 7 Wide-field eyepiece for spectacle wearers, with eyecups
- 8 Various ErgoModules™ or accessories for video, photography, drawing, fluorescence, coaxial incident light etc.

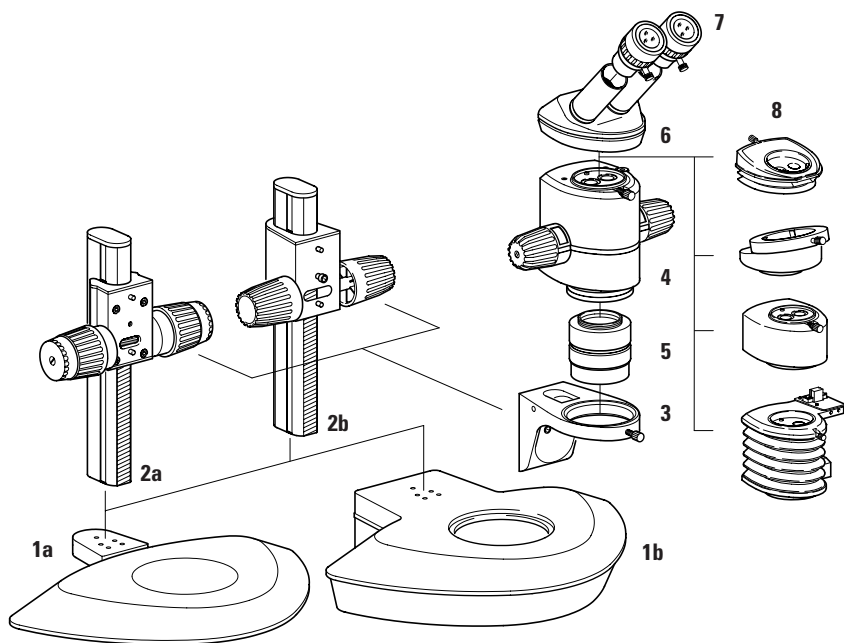

**Side-faced column →
incident-light base**

**Stand
Incident-light stand**

- ▶ Remove the stage plate.
- ▶ Insert 3 Allen screws into the underside of the baseplate and secure them to the bottom end of the side-faced column.
- ▶ Insert the stage plate.

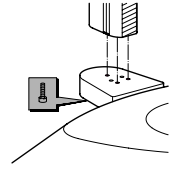

To fit the microscope carrier and the stereomicroscope, see page 34

**Side-faced column →
transmitted-light base**

Transmitted-light stand



Pull the power cable out of the socket in the stand.

- ▶ Remove the glass stage plate.
- ▶ Carefully invert the transmitted-light base and remove 7 Allen screws from the base.
- ▶ Lift off the lower part of the base.
- ▶ Reverse the upper part of the base.
- ▶ Insert 3 Allen screws into the cover plate from beneath and secure them to the bottom end of the side-faced column.
- ▶ Replace and secure the base.
- ▶ Insert the glass stage plate.
- ▶ Fit the microscope carrier and the stereomicroscope as described on page 34.

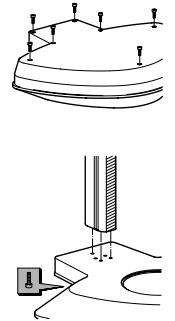

Technical data see page 74

Transmitted-light stand, bright field, 20 W



Follow the safety instructions given on page 7.

- ▶ Fit the side-faced column to the transmitted-light base as described on page 23.

Fitting the bulb



Never touch the bulb when it is hot.
You may sustain burns.

- Do not touch the new 6 V/20 W halogen bulb directly with your fingers, because finger marks can cause it to crack when heated.
Remove finger marks immediately with a cloth dipped in pure alcohol.
- ▶ Insert the slider together with the bulb socket.
- ▶ Hold the new bulb in a cloth and push it into position.
- ▶ Push the slider carefully but completely back along the rail to the stop.

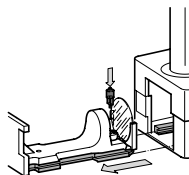

Filters

- The transmitted-light stand contains a KG1 filter.
- You can insert other \varnothing 50 mm filters if you need them:
- ▶ Pull out the slider.
- ▶ Insert the \varnothing 50 mm filter.
- ▶ Push the slider carefully but completely back along the rail to the stop.

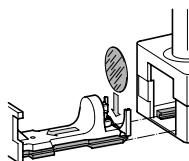

Starting up

The ex-factory setting of the voltage selector is 230 (for voltages between 200–240 V) and the fuse holder contains two 160 mA T fuses.

For 100–120 V power supply:

- ▶ Set the voltage selector to 115.
- ▶ Fit the enclosed two 315 mA T fuses in the fuse holder instead of the two 160 mA T fuses (see the section "Changing fuses" on the right).
- ▶ Connect the power cable to the socket of the base and to the power source.

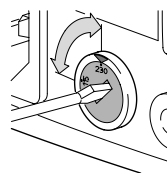

Changing fuses

Use:

- Two 160 mA T fuses for voltages between 200–240 V.
- Two 315 mA T fuses for voltages between 100–120 V (see the section "Starting up" on the left).

- ▶ Disconnect the power cable from the stand.
- ▶ Pull out the fuse holder.
- ▶ Fuse at rear: Press out downwards.
- ▶ Spare fuse at front: Pull out sideways and insert into holder at rear.
- ▶ Push the fuse holder back into position.

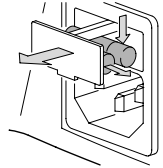

Transmitted or incident light

On the rear side of the base, there is a socket for incident lamps of up to 20 W.

- Connect an incident lamp to the transmitted-light stand, if required.
- Either transmitted light or incident light can be switched on.

- ▶ For transmitted light: Switch in position I.
- ▶ For incident light: Switch in position II.
- ▶ Use thumb wheel to adjust brightness.

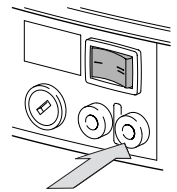

Switching on the transformer

- ▶ On the rear of the stand: Use the thumb wheel to switch on the transformer and to adjust the brightness.

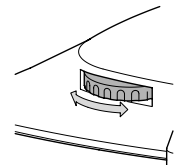

Disconnection from mains power supply

- ▶ Remove the power cable from the power socket.

Transmitted light

- ▶ Switch on transmitted light.

Transmitted light, bright field

Bright field is suitable for examining translucent objects featuring contrasting structures. The object is directly illuminated from below and is seen in its natural colors against a bright background.

- ▶ For transmitted light, bright field: Pull lever forwards.

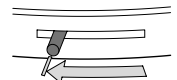

Inclined transmitted light

Inclined transmitted light which traverses the object obliquely will produce effects advantageous for observing small translucent objects such as foraminifera and fish eggs.

- ▶ Move the lever slowly towards the column of the stand until the desired effect is obtained.

Transmitted-light stand, bright and dark field

The illumination of the transmitted-light stand bright and dark field consists of a fiber-optic light guide and a light source.



Observe the safety regulations from the manufacturer of the light source.

- ▶ Unplug the fiber-optic light guide from the connection in the stand.
- ▶ Fit the side-faced column to the transmitted-light base as described on page 23.
- ▶ Fit the microscope carrier and stereomicroscope as described on page 34.
- ▶ Attach the fiber-optic light guide at the stand and the light source.

Starting up

Before using the light source, read the corresponding user manual.

Transmitted light, bright field

Bright field is suitable for examining translucent objects featuring contrasting structures. The object is directly illuminated from below and is seen in its natural colors against a bright background.

- ▶ Slide handle to the right until the stop: bright field.

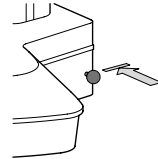

Transmitted light, dark field

Dark field offers more information for objects poor in contrast with rather poorly marked or very fine structures. In this case, the light beams penetrate the object at a flat angle. Fine detail structures and contours contrast brilliantly and brightly from dark background.

- ▶ Slide the handle out to the right: dark field.

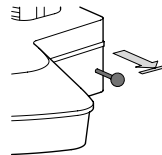

Transmitted-light stand HL

Column → Base

The column seat contains Allen screws.

- ▶ Remove the glass stage plate.
- ▶ Invert the transmitted-light base and place it on a table.
- ▶ Hold column against the column seat from underneath.
- ▶ Insert the Allen screws into the column from the top and tighten them.
- ▶ Invert the transmitted-light base and insert the glass stage plate.
- ▶ Fit additional components such as the microscope carrier and optics carrier (page 34).

Illumination

Add a very luminous cold light source and a light guide with a channel to the transmitted-light stand (TVC, active \varnothing 9 mm).

- ▶ Insert light guide into the base at the rear.
- ▶ Connect light guide to the light source.

Accessory condenser → Basis

For stereomicroscopes with high apertures such as Leica MZ12s, MZ16 and MZ16 A with objective 1.6 \times , the resolution can be increased by inserting an accessory condenser.

- ▶ Push the accessory condenser into the lens holder at the underside of the transmitted-light base and secure it with 2 Allen screws.

Use

- ▶ Turn on the light source according to the manufacturer's user manual and adjust the light intensity.
- ▶ Place a transparent object on the glass stage plate and focus.

Tilted mirror

The built-in mirror features a clear and an obscured side and can be rotated and moved. The obscured side provides a diffrused illumination. The angle of incidence in the specimen plane changes depending on the position of the mirror so that the transmitted light bright field via oblique illumination can also generate an illumination similar to dark field.

- ▶ Rotate and move the mirror with the black rotary knob on the right side.
- ▶ Adjust exact bright field and maximum illumination: move mirror to the stand column until it stops.
Rotate the mirror until it engages in the 45° position.

Transmitted-light stand HL-RC™

Detailed information about setup, operation and use can be found in the separate instructions for use M2-216-2.

Swinging-arm stand ESD

The swinging-arm stand ESD is of conducting material (surface resistance $<10^{11}$ Ohm/squared, discharge time <2 seconds from 1,000 V to 100 V). Two sockets for connecting $\varnothing 4$ mm ground cables are provided on the base.

Assembly of column → base

- ▶ Insert 4 Allen screws into the base from beneath and secure them to the end of the column.

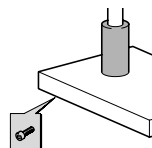

Safety ring → column

 **The safety ring secures the instrument and must always be fixed beneath the cross-member.**

- ▶ Slide the safety ring down the column.
- ▶ Retighten the clamping screw.

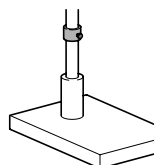

Cross-member → column

- ▶ Lower the cross-member onto the safety ring.
- ▶ Retighten the clamping screw.

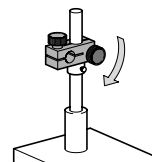

Horizontal arm → cross member

- ▶ Slide the horizontal arm into the cross-member with the connecting piece towards you.
- ▶ Retighten the clamping screw.

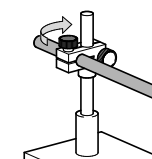

Drive housing → horizontal arm

- The drive housing / microscope carrier can be fitted to the horizontal arm in either of two positions (see page 34).
- The circular port in the microscope carrier accepts an illuminator.
- ▶ Insert the peg of the inclinable focusing drive into the connecting piece.
- ▶ Retighten the clamping screw.

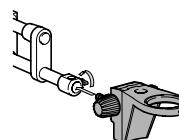

Optics carrier → microscope carrier

- ▶ Fit the optics carrier in the microscope carrier.
- ▶ Turn the optics carrier sideways in the microscope carrier as required.
- ▶ Retighten the clamping screw.

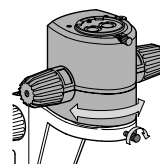

Focusing The focusing knobs are located on the inclinable drive housing. Is the focus movement too loose or too tight? Does the outfit tend to slide downwards? You can adjust the movement in accordance with the weight of the outfit and with your own personal requirements:

- ▶ Hold the drive knobs firmly with both hands and turn them in opposite directions until you obtain the required degree of resistance during focusing.

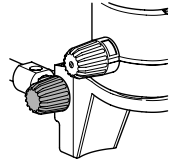

Possible adjustments

Tilting

- ▶ Release the clamping screw.
- ▶ Tilt the instrument.
- ▶ Retighten the clamping screw.

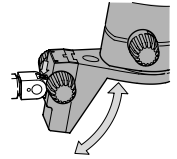

Altering the working distance

- ▶ Release the clamping screw.
- ▶ Raise or lower the cross-member as required together with the horizontal arm.
- ▶ Retighten the clamping screw.

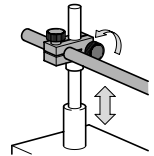

Reposition the safety ring (see page 28).

Sideways movement

- ▶ Release the clamping screw.
- ▶ Move the instrument sideways on the cross-member.
- ▶ Retighten the clamping screw.

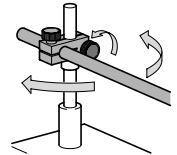

Altering the overhang

- ▶ Release the clamping screw.
- ▶ Displace the horizontal arm.
- ▶ Retighten the clamping screw.

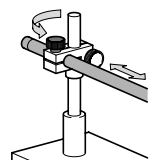

Large swinging-arm and table-clamp stands

Table-clamp stand

- ▶ Use the clamp to secure the column to a table top 20 mm – 50 mm thick.

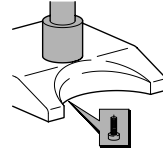

Swinging-arm stand

- ▶ Insert 4 Allen screws into the base from beneath and secure them to the end of the column.

Safety ring → column

 **The safety ring secures the instrument and must always be positioned beneath the horizontal arm.**

- ▶ Position the safety ring with the screw head uppermost and towards you, and slide it down the column.
- ▶ Retighten the clamping screw.

Safety ring → column

- ▶ Lower the horizontal arm onto the safety ring, with its end pointing towards you.
- ▶ Retighten the clamping screw.

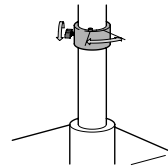

Limitation

The screw head must engage the notch. It limits the lateral movement. It may not be removed, and neither may the safety ring be milled down.

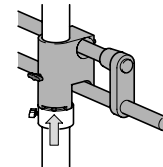

If the horizontal arm is swung out beyond the limit, the instrument may fall over.

Drive housing → horizontal arm

This section describes the assembly of the focusing drive with side-faced carrier rod. To fit the focusing drive with peg, refer to page 28.

- ▶ Release the clamping lever.
- ▶ Tilt the carrier rod downwards.
- ▶ Retighten the clamping lever.

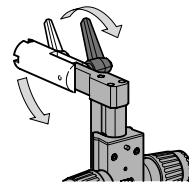

- ▶ Slide the drive housing with side-faced carrier rod onto the horizontal arm.
- ▶ Retighten the clamping lever.

The clamping levers can be positioned as required.

- ▶ Pull out the clamping lever along its axis and turn it.

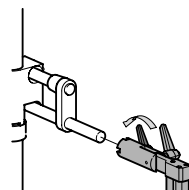

**Microscope carrier →
drive housing**

- ▶ Secure as described on page 34.

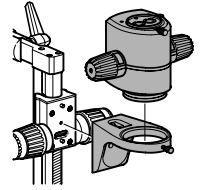

**Optics carrier →
microscope carrier**

- ▶ Secure as described on page 34.

Possible adjustments

Tilting

- ▶ Release the clamping lever.
- ▶ Tilt the instrument.
- ▶ Retighten the clamping lever.

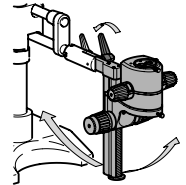

**Focusing with
coarse/fine drive**

- ▶ Set large distances with the larger knob.
- ▶ Fine-focus with the smaller (concentric) knob.
- ▶ Using the ring on the right-hand drive knob, adjust the ease of movement of the drive.

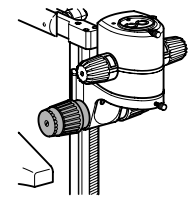

**Altering the working
distance**

- ▶ Release the clamping screw.
- ▶ Raise or lower the horizontal arm.
- ▶ Retighten the clamping screw.

Reposition the safety ring (see page 30).

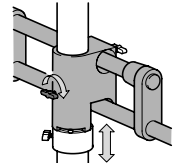

Sideways movement

- ▶ Release the clamping screw.
- ▶ Pull out or push in the horizontal arm.
- ▶ Retighten the clamping screw.

**During the sideways movement,
observe the limit stops (see page 30).**

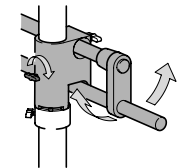

Altering the overhang

- ▶ Release the clamping screw.
- ▶ Displace the horizontal arm.
- ▶ Retighten the clamping screw.

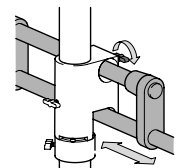

Optics carrier, optical accessories

Spacer rings

Spacer rings are required in order to attach the objectives for certain instrument configurations.

- The Leica MZ95 is supplied with a spacer ring (10 446 393) for the smaller-diameter achromatic objectives and 1× planachromatic objective. When the spacer ring has been removed by applying the tool provided, the larger-diameter planachromatic and planapochromatic objectives for the MZ125/MZ16 can be used.
- The Leica MS5, MZ6 and MZ75 can also be equipped with the larger-diameter planachromatic and planapochromatic objectives for the MZ125/MZ16 if a spacer ring is fitted (10 446 172).
- When the MZ125/MZ16 planachromatic and planapochromatic objectives are used on the Leica MS5, MZ6, MZ75 and MZ95, the magnification is increased by the factor 1.25x.

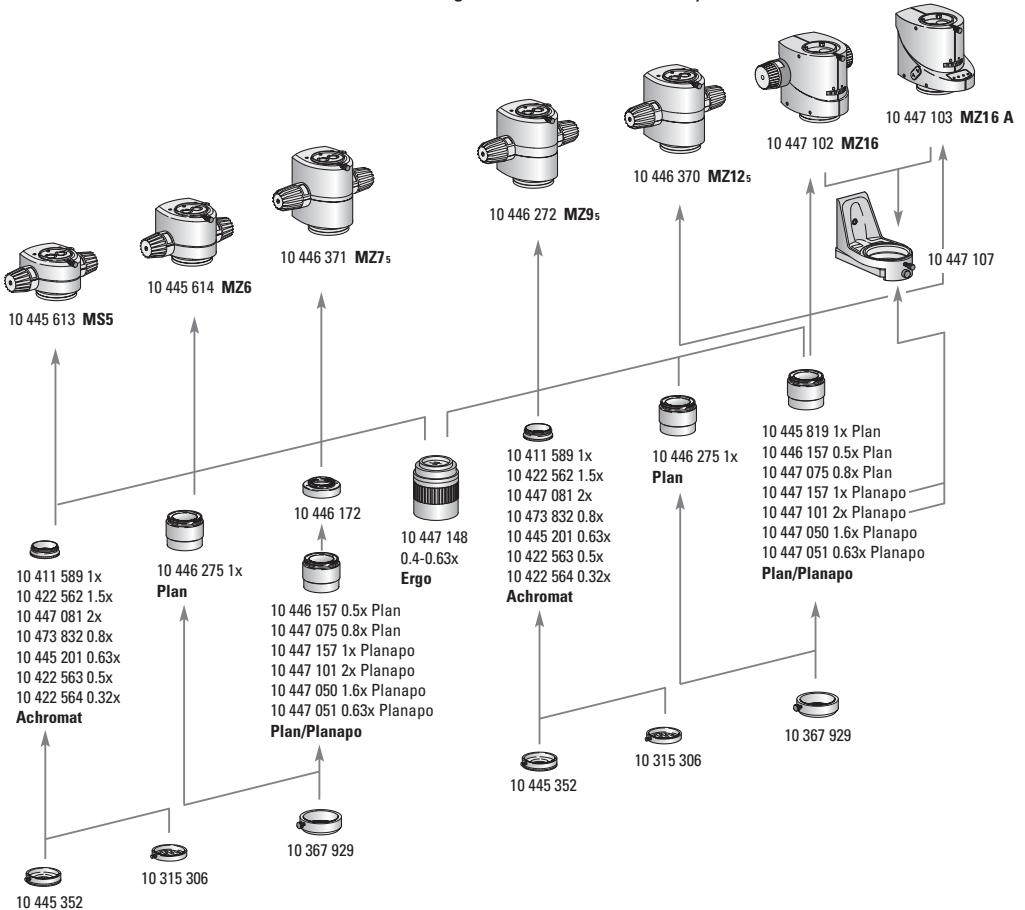

Objective combinations

	Part no.	MS5	MZ6	MZ7s	MZ9s	MZ12s	MZ16/MZ16 A
Achromat							
Achromat 1×	10 411 589	C	C	C	C		
Achromat 1.5×	10 422 562	C	C	C	C		
Achromat 2×	10 447 081	C	C	C	C		
Achromat 0.8×	10 473 832	C	C	C	C		
Achromat 0.63×	10 445 201	C	C	C	C		
Achromat 0.5×	10 422 563	C	C	C	C		
Achromat 0.32×	10 422 564	C	C	C	C		
Ergo objective 0.4× – 0.63×	10 447 148	C	C	C	C		
Planachromatic							
Planachromatic 1×	10 446 275	C	C	C	C		
Planachromatic 1× MZ12s/MZ16	10 445 819	CA (10 446 172) M	CA (10 446 172) M	CA (10 446 172) M	C*M	C	C
Planachromatic 0.5× MZ12s/MZ16	10 446 157	CA (10 446 172) M	CA (10 446 172) M	CA (10 446 172) M	C*M	C	C
Planachromatic 0.8×	10 447 075	CA (10 446 172) M	CA (10 446 172) M	CA (10 446 172) M	C*M	C	C
Planapochromatic							
Planapochromatic 1× MZ12s/MZ16	10 447 157	CA (10 446 172) M	CA (10 446 172) M	CA (10 446 172) M	C*M	C	C
Planapochromatic 1.6× MZ12s/MZ16	10 447 050	CA (10 446 172) M	CA (10 446 172) M	CA (10 446 172) M	C*M	C	C
Planapochromatic 0.63× MZ12s/MZ16	10 447 051	CA (10 446 172) M	CA (10 446 172) M	CA (10 446 172) M	C*M	C	C
Planapochromatic 2× MZ12s/MZ16	10 447 101	CA (10 446 172) M	CA (10 446 172) M	CA (10 446 172) M	C*M	C	C
Accessories							
Coaxial incident light	10 446 180	C	C	O (10 446 300)	O (10 446 300)	C	C
Microscope carrier AX MS5, MZ6, MZ7s, MZ9s	10 445 618	C	C	C	C		
Microscope carrier AX MZ12s, MZ16, MZ16 A	10 447 062	CA	CA	CA	C	C	C
Near vertical illuminator	10 445 198	C	C	CA 2× (10 446 300)	CA (10 446 300)	CA (10 446 300) + (10 446 393)	CA (10 446 300) + (10 446 393)
Attachment for vertical and oblique observation	10 445 156	C	C	CA 2× (10 446 300)	CA (10 446 300)	CA (10 446 300) + (10 446 393)	CA (10 446 300) + (10 446 393)
Objective turret for 2× and 1× planapo objectives	10 447 107	(C)	(C)	(C)	(C)	(C)	C

C Compatible

CA Compatible if used with intermediate ring (order separately)

O Intermediate ring is recommended

M Magnification increased by factor 1.25× or higher

* Remove intermediate ring (10 446 393); already included with MZ9s.

(C) Large fields of view at low magnifications are not fully illuminated.

Microscope carrier

Microscope carrier → drive housing

The microscope carrier can be attached to the focusing drive in 2 positions:

- For short working distances and for flat objects, use Position 1. Use this position also in conjunction with the attachment for vertical and oblique observation (see detailed instructions).
- Use Position 2 for long working distances and for bulky objects.
- ▶ Use an Allen screw to secure the microscope carrier in the position required.

A connection socket for a \varnothing 4 mm grounding cable is provided on the microscope carrier.

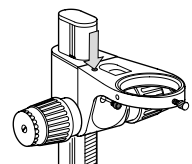
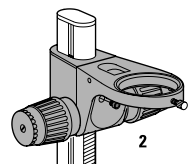
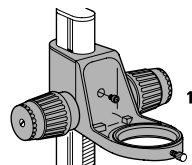

Microscope carrier AX

- Different models are available for MS5, MZ6, MZ7_s, MZ9_s and for MZ12_s, MZ16 and MZ16 A (see p. 18).
- The microscope carrier AX can only be fitted in position 1 to the focusing drive.

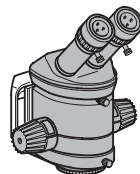

Optics carrier

Optics carrier → microscope carrier

- ▶ Gently lower the optics carrier into the microscope carrier.
- ▶ Use the screw to secure the optics carrier in the position required.

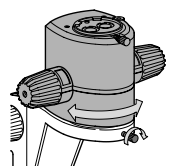

Apply the adhesive scale of magnifications

- Only for MZ7_s:
- ▶ Remove the screws.
 - ▶ Remove the rotary knobs.
 - ▶ Apply the adhesive scales.
 - ▶ Replace the rotary knobs.

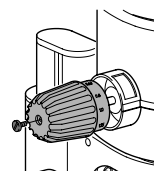

Binocular tube

- ▶ Release the clamping screw.
- If you have an accessory such as an ergo module (page 14), a coaxial illuminator (page 47) or a video/phototube (page 52), fit it now to the optics carrier. Tighten the clamping screw.
- ▶ Tilt the binocular tube and insert the edge of its dovetail ring beneath the two lugs on the optics carrier.
- ▶ Move the binocular tube from side to side until the locating screw on the optics carrier engages the guide.
- ▶ Retighten the clamping screw.

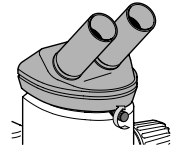
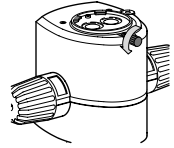

Optical accessories

Eyepiece

- ▶ Insert a graticule, if necessary (page 56).
- ▶ Release the clamping screws on the eyepieces.
- ▶ Insert the eyepieces **fully** into the eyepiece tubes. Check that they have seated correctly.
- ▶ Tighten the clamping screw.
- You can extend the overall magnification range by using 10 \times , 16 \times , 25 \times and 40 \times wide-eyepieces for persons wearing glasses.

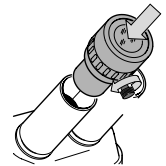

Objective



Hold the objectives during assembly and disassembly to prevent them from falling on the stage plate. This applies particularly to the 2 \times planapochromatic objective, which is very heavy. Remove the specimens from the stage plate.

- ▶ Screw on the selected objective counter-clockwise.

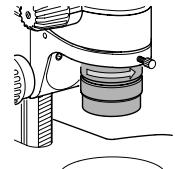

- Some instrument configurations require spacer rings in order to secure the objectives (page 32). These rings are fitted and removed using the tool provided.
- The Leica MZ9_s is supplied with a spacer ring for the achromatic objectives and for the 1 \times planachromatic objective. When the spacer ring has been removed by applying the tool provided, the larger-diameter planachromatic and planapochromatic objectives for the MZ12_s/MZ16 can be used.

Objective nosepiece

- Suggested for Leica MZ16 and MZ16 A



Please note: When using the objective nosepiece together with MS5, MZ6, MZ7_s, MZ9_s or MZ12_s large fields of view at low magnifications are not fully illuminated.



- Hold objectives during assembly and disassembly to prevent them from falling on the stage plate. This applies particularly to the 2× planapochromatic objective, which is very heavy. Remove the specimens from the stage plate.
- The adjustable ring nut with the 1× planapochromatic objective is fastened with 2 Allen screws after the adjustment. Loosen the Allen screws if you need to remove the objective.
- Attach the limit stop to the stand column. It prevents the 2× objective from hitting the limit stop when the objective nosepiece is rotating, if the working distance was changed ×while working with the 1 objective.
- **Caution:** Carefully rotate the objective nosepiece and take care not to pinch your fingers between column and objective or objective nosepiece.



MZ16 A: When changing to objective 1× or 2×, press the **OPT + SEL** function keys simultaneously. The display shows the current total magnification, and in **REF** mode it shows the current measurement with objective 1× or 2×. A **1** or **2** in front of the value indicates the selected objective.

Preparation

- Remove the securing strap from the objective nosepiece:
- ▶ Remove both screws (at the bottom).

Leica MZ16 and MZ16 A are delivered with a threaded adapter for objectives. Remove the adapter to use the objective nosepiece.

- ▶ Invert the optics carrier.
- ▶ Loosen 3 screws and remove the adapter.

Assembling 1× planapochromatic

The objective nosepiece features two threads:

- a fixed thread for the 2× planapochromatic objective
- a thread with 2 Allen screws for the 1× planapochromatic objective with adjustable ring nut. The adjustable ring nut is supplied separately and used to adjust the parfocality between both objectives.

Invert the objective nosepiece to simplify the assembly of the objectives.

- ▶ Screw on the adjustable ring nut on the thread of the 1× planapochromatic objective until the limit stop and tighten it with the enclosed wrench.
- ▶ Screw in the 1× planapochromatic objective with the ring nut in clockwise direction on the side with the 2 Allen screws.
- The fine-pitch thread on the ring nut consists of 24 threads. You should expect at least 40 turns.



The adjustable ring nut must never be set higher than the top surface of the nosepiece plate to prevent the nosepiece from locking while rotating.

Assembling 2× planapochromatic

- ▶ Carefully turn and tighten the 2× planapochromatic objective clockwise to the limit stop without applying excessive force.



Assembling objective nosepiece

- ▶ Raise the focusing drive with the drive heads to provide sufficient space for the 2× planapochromatic objective.
- ▶ Fit the objective nosepiece like a microscope carrier with the Allen screw (see page 34, position 1).
- ▶ Insert the optics carrier in the objective nosepiece.
- ▶ Retighten the clamping screw.
- ▶ Attach the limit stop to the column of the stand so that the working distance beneath the 2× objective will always measure approx. 15 mm.

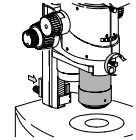

Adjusting parfocal

- Fit and adjust the 1× and 2× planapochromatic objectives as described. The image then remains parfocal in the range of <math>< 0.05\text{ mm}</math>, and refocusing after changing the objective is no longer required.
- Use a very fine, flat object (e.g. an object micrometer) for the adjustment, which allows maximum focusing even at highest resolution.

- ▶ Screw the 2× planapochromatic objective into the beam path.
- ▶ Adjusting the diopter settings and parfocality (see p. 20).
- ▶ Screw the 1× planapochromatic objective into the beam path.
- ▶ Observe the same object with smallest magnification without changing the settings made with the 2× planapochromatic objective.

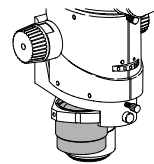

- ▶ Turn the 1× planapochromatic objective counter-clockwise until the object can be seen in focus at the smallest magnification.
- ▶ Slowly zoom to the highest magnification. At the same time correct the focus by turning the 1× planapochromatic objective.

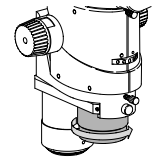

- Verify that the object is in focus at highest magnification with the 2× planapochromatic as well as the 1× planapochromatic objective without refocusing. Otherwise turn the objective at the ring nut until the object is focused.
- ▶ Fasten the ring nut with both screws. Do not overtighten both screws.

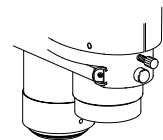

Transformers



Follow the safety instructions given on page 7. Leica transformers may only be opened by authorized service personnel, and the power cable must be disconnected beforehand. The transformers are not to be used outdoors.

Regulating transformer

The regulating transformer 5.3 to 7.5 V/40 VA is used to operate the 6 V/10 W and 6 V/20 W lamps.

- 1 Connections for two lamps (maximum combined loading 40 W)
- 2 Connection for power cable
- 3 Fuse holder 2x T 1A L 250 VA
- 4 Power switch
I on
0 off
- 5 ON display: Instrument is switched on.
- 6 Regulating knob
- 7 6 V display: The standard voltage has been reached.

Technical data see page 74

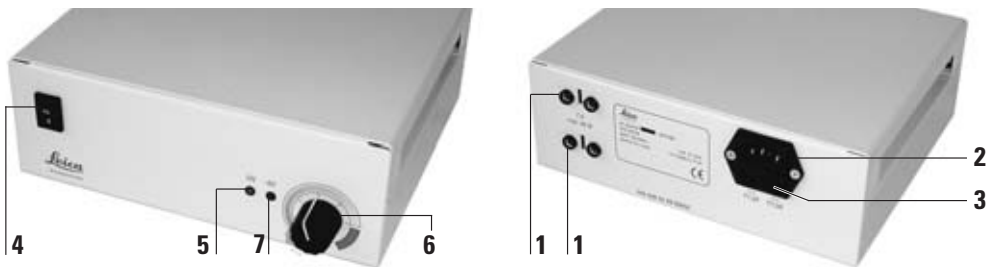

Starting up

Switching the input voltage is not necessary. The adjustment is carried out automatically by means of the switching controller in the regulating transformer.

- ▶ Connect the power cable to the socket of the base and to the power source.
- ▶ Connect the lamp. The sockets accept two lamps with a maximum combined loading of 40 W.

Switching on and off

You can prolong the life of your bulb if you:

- ▶ First switch off the lamp by turning the rotary knob into the black range
- ▶ and only then switch the transformer on or off.
- ▶ Turn on the power switch. The diode is illuminated.

- ▶ Use the rotary knob to adjust the brightness. Above 6 V the diode is illuminated.

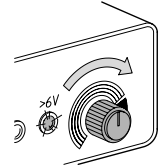
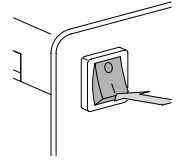

Changing fuses

Fuses 1.0A, 5x20 (stock no. 167 651)

- ▶ Lamp off.
- ▶ Power switch off.
- ▶ Use a flat-bladed screwdriver to press on the slots in the fuse holders (3) and turn the fuse holders to the left. Pull out the fuse holder.
- ▶ Fit a new fuse and replace the fuse holder.

In the event of overload

- ▶ Lamp off.
- ▶ Power switch off.
- ▶ Wait a few seconds.
- ▶ Power switch on.
- ▶ Lamp on.

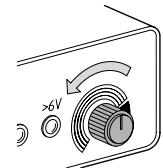

Step transformer

Follow the safety instructions given on page 7.

- You can attach a 6 V/10 W lamp to the step transformer.
- ▶ Set the voltage selector on the rear side to 115 V or 230 V.
- ▶ Attach the power cable to the power supply.
- ▶ Connect the lamp.
- ▶ Adjust the brightness with the three-step switch (4/5/6 V).

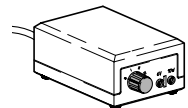

6 V/10 W incident lamp

- The 6 V/10 W lamp is an inclined incident source for illuminating spatial objects
- By using two lamps, you can soften or eliminate shadows.
- At the nominal voltage (6 V), the color temperature is 2700 K.

- Assembly**
- ▶ Release the clamping screw.
 - ▶ Unfold the lampholder arm.
 - ▶ Retighten the clamping screw.



- Lampholder → clamp for side-faced columns**
- ▶ Use the screw to secure the clamp to the side-faced column, either above or below the focusing drive.

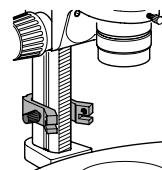

- ▶ Use the connector to attach the lampholder arm to the clamp, on either the right or the left.

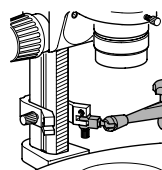

- Lampholder → cast foot**
- ▶ Fit the $\varnothing 25$ mm adapter to the cast foot.
 - ▶ Using the connector, attach the lampholder to the adapter.

- Lampholder → objective**
- ▶ Remove the objective.
 - ▶ Slide the adapter over the objective.
 - ▶ Using the connector, attach the lampholder to the adapter.

- Lampholder → inclinable focusing drive**
- ▶ Unscrew a connector from the lampholder.
 - ▶ Release the clamping screw.
 - ▶ Using the thread, secure the lampholder to the focusing drive.
 - ▶ Retighten the clamping screw.

- Lamp housing → lampholder arm**
- ▶ Attach the lamp to the connector on the lampholder arm.
 - ▶ Fit the filter holder, complete with KG1 heat-absorbing filter, to one of the pegs.
 - A total of 4 filter holders with $\varnothing 50$ mm filters can be attached.

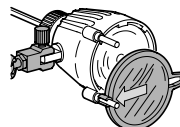

Operating the lamp



Observe the safety notes on page 7.
Observe the notes with respect to the use of the transformer on page 38.

- ▶ Connect the cable between the lamp housing and the transformer (page 38).
- ▶ Switch on the transformer and use the rotary knob to adjust the brightness (page 39).

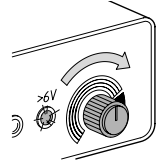

- ▶ Hold the lamp housing and release the clamping screw.
- ▶ Align the light spot with the object.
- ▶ Retighten the clamping screw.

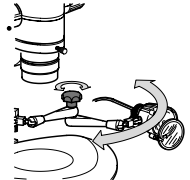

- ▶ Swing in the heat-absorbing filter.

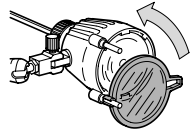

- ▶ Enlarge or reduce the size of the light spot by turning the socket of the bulb.

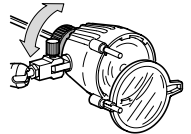

Changing the bulb



Disconnect the lamp cable from the transformer.



Never touch the bulb when it is hot.
You may sustain burns.

- You can separate the lamp housing and the bulb socket. Line up the arrow head on the mount with its shaft on the housing.
- Do not touch the 6 V/10 W halogen bulb because finger marks can cause it to crack when heated. Remove finger marks with a cloth dipped in alcohol.
- ▶ Turn the socket to the separation position.
- ▶ Pull the socket forcibly out of the housing.
- ▶ Hold the new bulb in a cloth and push it into position.
- ▶ Replace the socket in the housing. The socket clicks into position.

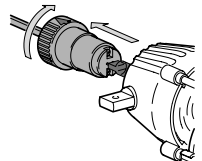

6 V/20 W incident lamp

- The 6 V/20 W lamp is an inclined incident source for illuminating spatial objects.
- By using two lamps, you can soften or eliminate shadows.
- At the nominal voltage (6 V), the color temperature is 3200 K, ideal for photography. Set the regulating transformer to this nominal voltage (see page 38).

Assembly

- ▶ Release the clamping screw.
- ▶ Unfold the lampholder arm.
- ▶ Secure the lampholder to the lamp.

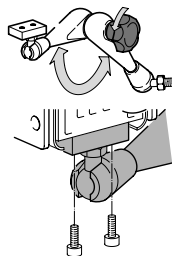

- ▶ Use the screw to secure the clamp to the side-faced column, either above or below the focusing drive.

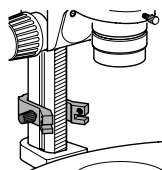

- ▶ Using a fork wrench and the thread connector, attach the lampholder arm to the clamp, on either the right or the left.
- ▶ Position the lamp.
- ▶ Retighten the clamping screw.

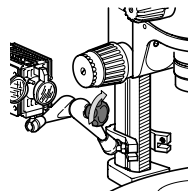

- The thread connector also enables the lampholder to be connected to the cast foot.

Diffusing and other filters

- A total of 4 filter holders with \varnothing 32 mm filters can be attached. A heat-absorbing filter is built in.
- ▶ Push the filter holder, complete with diffusing filter, onto one of the pegs, and swing it in.

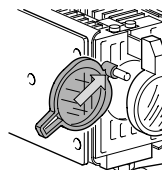

Operating the lamp



Observe the safety notes on page 7.
Observe the notes with respect to the use of the transformer on page 38.

- ▶ Connect the cable between the lamp housing and the transformer (page 38).
- ▶ Switch on the transformer and use the rotary knob to adjust the brightness.

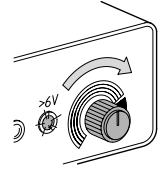

Illuminating the object

- ▶ Push the condenser lens forwards or backwards until the slider engages.

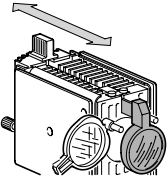

- ▶ Hold the lamp housing and release the clamping screw.
- ▶ Align the light spot with the object.
- ▶ Retighten the clamping screw.

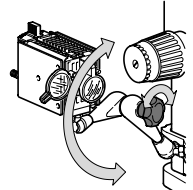

- ▶ Adjust the size of the light spot by moving the condenser lens forward or back.

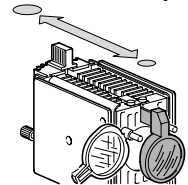

- ▶ If necessary, swing in a filter (page 42).

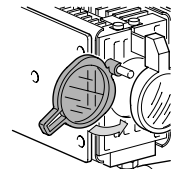

Changing the bulb



Disconnect the lamp cable from the transformer.



**Never touch the bulb when it is hot.
You may sustain burns.**

- Do not touch the 6 V/20 W halogen bulb directly with your fingers, because finger marks can cause it to crack when heated. Remove finger marks immediately with a cloth dipped in pure alcohol.
- ▶ Press the spring clips together and pull off the rear part of the housing.
- ▶ Hold the new bulb in a cloth and push it into position.
- ▶ Press the spring clips together and close the housing again.
- ▶ Center the bulb.

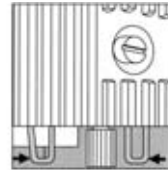

Centering the bulb

The 6 V/20 W bulb is a powerful source of illumination. The more carefully you set it up, the more uniform the lighting will be. For this reason, recenter a new bulb after fitting it.

- ▶ Switch on the lamp.
- ▶ Swing out the diffusing filter.
- ▶ Pull the condenser lens fully out.
- ▶ Hold the lamp and release the clamping screw.
- ▶ Point the lamp vertically downwards at a white sheet of paper so that two filament images are seen.
- ▶ Retighten the clamping screw.

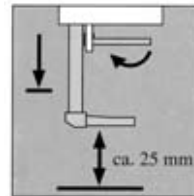

- ▶ Using the slotted screw, bring the two filament images into focus.

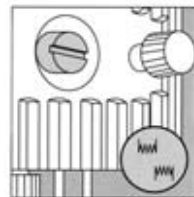

- ▶ Displace the filament images so that they are opposite to one another, but in contact.
- ▶ Swing back the diffusing filter.

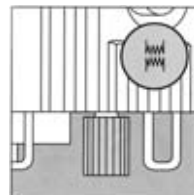

Leica L2 cold-light source

The antistatic Leica L2 cold-light source is powerful, small, compact, inexpensive and suitable for simple observation tasks with the Leica MS5 and MZ6 stereo microscopes. In addition to one or two-arm light guides, corresponding accessories are also available for the coaxial, vertical and transmitted-light illumination methods. The Leica L2 can be directly connected on the stand.

The light guides can be mounted with arms in the threads on the microscope carrier. For instructions on mounting the clamp for fiber-optic light guides, see page 46.

For detailed information, refer to the separate user manual Leica L2 M2-288-0.



When in use, the Leica L2 fiber-optic light source must always be locked into an adapter to ensure stability.

Adapter → 300 mm focusing drive

- ▶ Secure the clamp to the 300 mm focusing drive by tightening the screw.
- ▶ Using the mounting rail, slide the fiber-optic light source into the adapter fork until it engages.

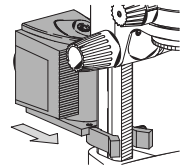

Adapter → baseplate

- When mounted on the baseplate, the light source can be used as a stand-alone unit.
- ▶ Using the mounting rail, slide the fiber-optic light source into the adapter fork until it engages.

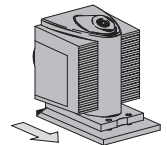

Cold light source Leica CLS series

The Leica CLS series is a high-performance line for high light intensity within the smallest possible space and flicker-free white light with the lowest possible thermal effect on the objects. The comprehensive line of accessories enables unlimited use. The CLS series is produced of antistatic material.

When using the ring lamp (\varnothing 76 mm) on the planachromatic objective 0.8 \times (\varnothing 80 mm), a special adapter (10 447 078) is required.

For a detailed information, refer to the user manual Leica CLS.

Fiber-optic light guide

- The clamp of the fiber-optic light guide cannot be attached to the microscope carrier AX.

- ▶ Turn the clamping screw out of the clamp.

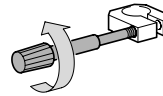

- ▶ Hold the clamp in the opening of the microscope carrier.
- ▶ Push the clamping screw through the holes in the microscope carrier and in the broader part of the clamp, and screw it finger-tight to the narrow part of the clamp.

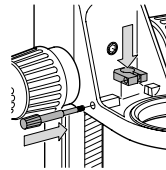

- ▶ Insert the fiber-optic light guide into the clamp.
- ▶ Switch on the power unit.
- ▶ Align the light spot with the object.
- ▶ Retighten the clamping screw.

Leica LED illumination

The Leica LED1000 (Laser Emitting Diode) illumination is available with ring illuminator and/or spot and suitable for routine tasks with the Leica MS5, MZ6, MZ7_s, MZ9_s stereomicroscopes. LEDs, which do not develop any heat, are used as illuminators. The color temperature measures 5000 K (daylight).

For details see the separate instructions for use for the LED illumination.

Supply (line) lamp 25W



Follow the safety instructions given on page 7.

- ▶ Fit the lamp holder and lamp as described below (incident-light lamp 6 V/10 W).
- ▶ Connect the 25 W supply (line) lamp to the power supply.
- ▶ Switch on the supply (line) lamp.
- ▶ Align the light spot with the object as described.

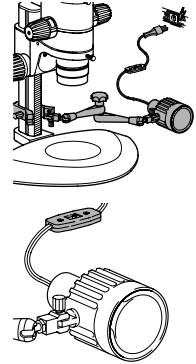

Coaxial illuminator

- This illuminator is for observing and photographing flat, highly-reflecting objects such as wafers, integrated circuits and polished metal sections.
- The coaxial incident light housing fits like an accessory tube between the optics carrier and the binocular tube, or between the optics carrier and the phototube (page 50).
- For the MZ7_s and MZ9_s, fit the objective preferably to the spacer ring (10 446 300), page 32. This will completely illuminate the largest field of view.

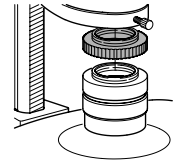

- A quarter-wave plate is required when the microscope carrier AX is used in the vertical position.
- ▶ Using the clamping screw, secure the quarter-wave plate to the objective mount.
- ▶ Using the knurled ring, turn the quarter-wave plate until the required effect is obtained.



Please observe the notes on the use of the aperture in the AX microscope carrier (p. 19).

Near-vertical illuminator

- The near-vertical (approx. 5°) light beam illuminates depressions and cavities.
 - Shadowing by tools is eliminated.
 - This illuminator can only be used with the achromatic objectives having focal lengths of 100, 150, 175 and 200 mm.
 - Spacer rings are required for the Leica MZ75, MZ95, MZ125 to secure the near-vertical illuminator to the optics carrier (page 32).
- Unscrew the objective.
► Release the clamping screw and remove the adapter ring from the incident-light housing for near-vertical light.

- For MS5, MZ6:**
- Screw the adapter ring onto the microscope carrier.
 - Secure the incident-light housing to the adapter ring.

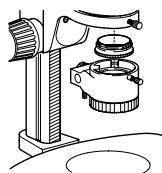

- For Leica MZ75, MZ95, MZ125:**
- First screw the spacer ring(s) (page 32) onto the microscope carrier, then screw the adapter ring to the spacer ring.
 - Secure the incident-light housing to the adapter ring.
 - Screw the achromatic objective (see above) into position.
 - Release the left or right clamping screw and change the cover plate accordingly.

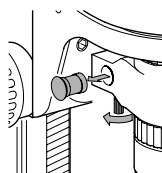
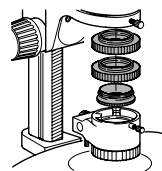

- ▶ Attach the fiber-optic light guide on either the left or the right.

To switch on the cold-light illuminator, refer to the user manual provided with it.

No light?

- ▶ Turn the rotary knob.
- A movable prism directs the light from the left or right outlet onto the object.

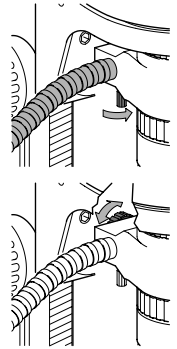

Accessories

Tubes

Assembly

- All accessory tubes which fit between the optics carrier and the binocular tube are fitted in the same manner.
 - In the dovetail ring of the optics carrier is a locating screw which must engage the notch in the accessory (page 35). This is best accomplished by moving the accessory slightly from side to side.
- ▶ Release the clamping screw.
 - ▶ Insert the accessory tube into the dovetail ring in the same manner as the binocular tube (page 35) and move it slightly from side to side until the locating screw engages the notch.
 - ▶ Retighten the clamping screw.
 - ▶ Fit the binocular tube on the accessory tube in the same manner.

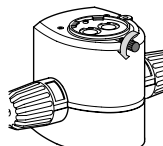

Double-iris diaphragm

A double-iris diaphragm is built into the MZ16 and MZ16 A. It is operated by means of a knurled ring. A separate double-iris diaphragm is available as accessory for the other instruments.

The double-iris diaphragm for MS5–MZ12s can be inserted between optics carrier and binocular tube or video/phototube.

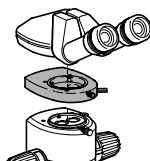

Set the lever to OPEN: The double-iris diaphragm (aperture diaphragm) is open.

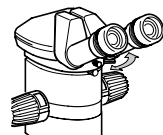

The depth of field increases as the lever is moved from OPEN to 1. Remember, however, that

- brightness decreases, so exposure times become longer
- resolution deteriorates.

Drawing tube

- The drawing tube is for both left-handers and right-handers. Fit the mirror on the left-hand or right-hand side of the optics carrier.
- ▶ Fit the drawing tube between optics carrier and binocular tube as described on page 50.
- ▶ Place a sheet of paper beneath the mirror.
- ▶ Use a table lamp to illuminate the paper.

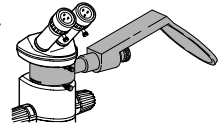

Drawing

- ▶ Move the lever to the circle.
- ▶ Look into the binocular tube, position the object, and focus on it.

- ▶ Move the lever to the black spot.
- ▶ Look into the binocular tube and balance the brightness so that the object, the drawing surface and the pencil are all seen together.

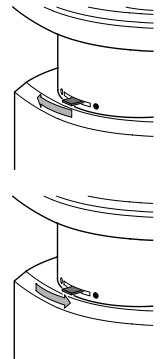

- In general, the paper needs to be illuminated strongly, but the object only weakly.
- ▶ Move the lens mount of the drawing tube forwards or backwards until the drawing surface is sharply imaged.
- ▶ Now you can draw the feature.
- If you place a graduated scale beneath the object and draw its intervals as well, you can easily determine the image scale on the paper.

Discussion tube

At the discussion tube two observers see the same erect, laterally-correct, three-dimensional image.

The assembly and use of the discussion tube are described in the separate user manual M2-263-0.

Video/phototubes

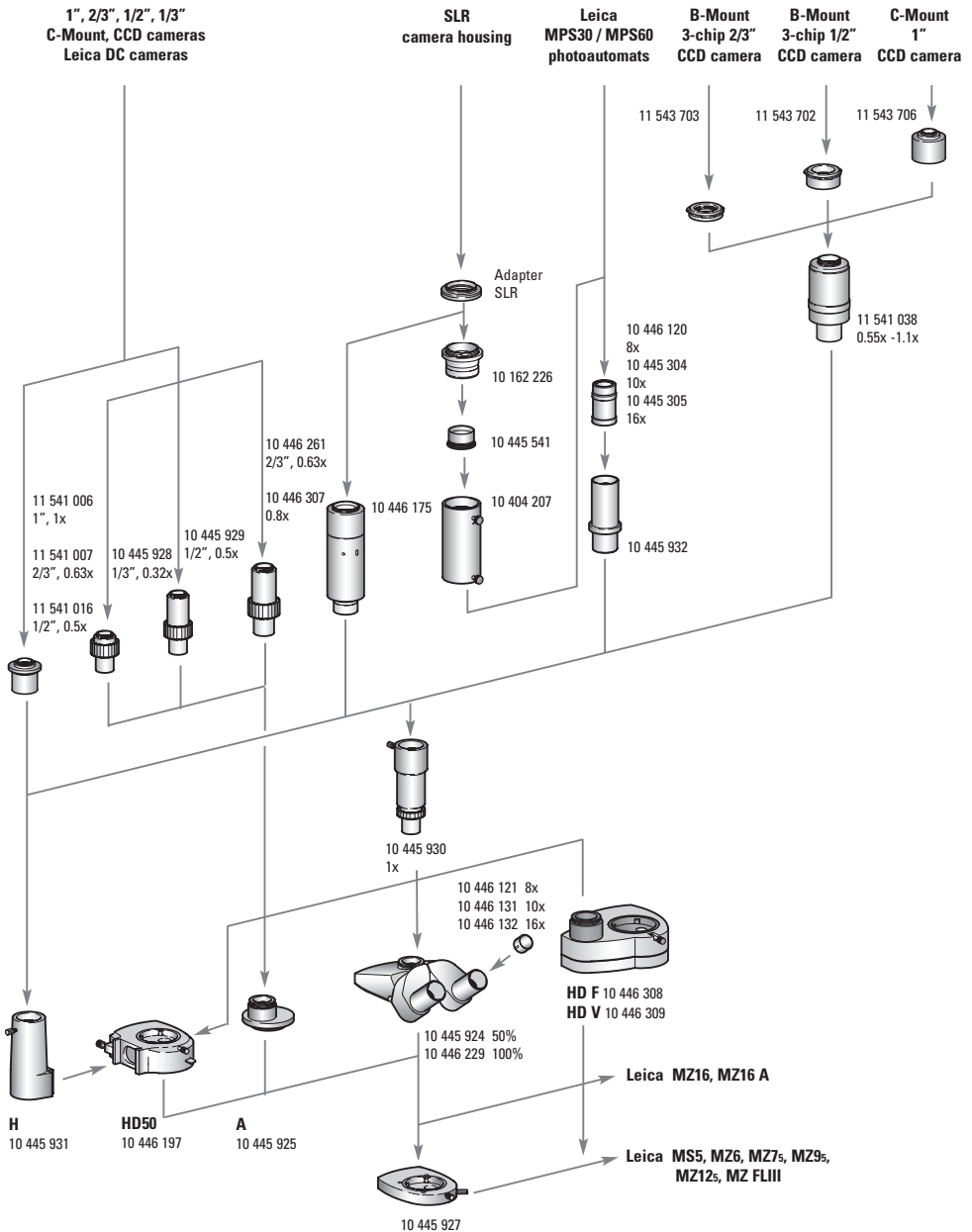

- Video/phototubes are designed to support modular photomicrography systems, and Leica digital, video, film or SLR cameras.
- The modular photomicrographic systems and the Leica digital cameras are detailed in a separate user manual, along with instructions for their assembly and use.
- When you are not taking photographs, engage the observation beam path.
- Accessories such as the coaxial incident illuminator always fit between the stereomicroscope and the phototube.

Video/phototube A

This tube does not permit stereoscopic observation. The image is studied either in the camera viewfinder, or down the focusing telescope of the camera. In the video/photo beam path, 100% light is available.

Trinocular video/phototube 50%

- ▶ Fit the trinocular video/phototube on the optics carrier in place of the binocular observation tube (page 35).

For examples on camera assembly see page 54.

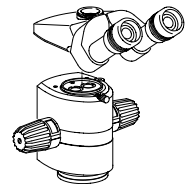

Partition of light

- 50% to both eyepieces
- 50% in the video/photo beam path

Stop

Before taking the photograph, close off the right eyepiece to keep out stray light.

- ▶ Move lever to the left.

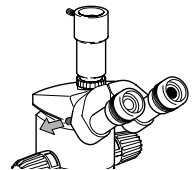

Trinocular video/phototube 100%

Fitting: See "Trinocular video/phototube 50%".

- Switchover**
- ▶ Observation: Push lever in.
 - ▶ Photography: Pull out lever to the left.

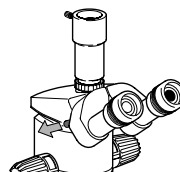

- Light partition setting "VIS"**
- 100% in both eyepieces.

- Light partition setting "PHOT"**
- 100% in the left eyepiece
 - 100% in the video/photo beam path.

Camera setup, variants As shown in the setup diagram on page 52, there are various possibilities for adapting an MPS, video, digital or SLR camera.

Example:

With this equipment you can, for example, attach an MPS camera (see detailed description in the MPS user manual), an SLR camera, or even a digital or video camera.

- ▶ Fit the 1× video/photo objective.

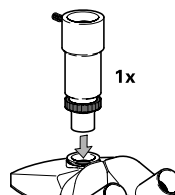

Example:

With this equipment you can, for example, attach a digital or video camera.

- ▶ Fit the video objective (2) on a Leica DC digital camera (3) with the C-mount connection.
- ▶ Connect the video objective with the mounted Leica DC digital camera on the right output of the video/phototube.
- ▶ Tighten the coupling ring (1).

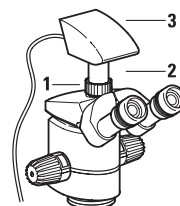

Video/phototube HD50

- ▶ Use the video/phototube HD50 between the optics carrier and the binocular tube (page 50).

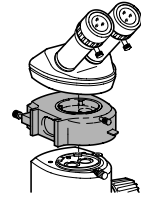

- Switchover**
- ▶ Observation: Push lever in.
 - ▶ Documentation: Pull lever out.

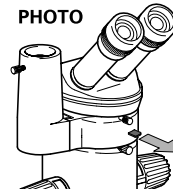
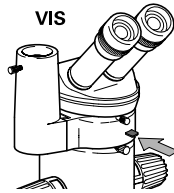

Light partition for "observation"

- 50% to both eyepieces
- 50% in the left-hand video/photo beam path
- 50% in the right-hand video/photo beam path

Light partition for "documentation"

- 100% to left video/photo beam path
- 50% to right eyepiece
- 50% in the right-hand video/photo beam path

Camera setup, variants

As shown in the setup diagram on page 52, there are various possibilities for adapting an MPS, video, digital or SLR camera.

Example:

- ▶ Fit the video/photo objective H on the left-hand side.

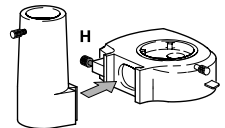

With this equipment you can, for example, attach an MPS camera (see detailed description in the MPS user manual), an SLR camera, or even a digital or video camera.

Example:

With this equipment you can, for example, attach a digital or video camera.

- ▶ Fit the video objective (2) on a Leica DC digital camera (3) with the C-mount connection.
- ▶ Connect the video objective with the mounted Leica DC digital camera on the right output of the video/phototube.
- ▶ Tighten the coupling ring (1).

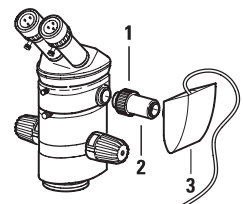

Attachment for vertical and oblique observation

- The attachment for vertical and oblique observation enables spatial objects to be observed from above, and also from all around at an angle of 45°.
- The microscope carrier must be fitted in the lower position 1 (page 34).
- For MS5, MZ6: Fit the 1× achromatic objective by screwing its adapter ring directly into the optics carrier.
- Spacer rings are required for the Leica MZ7_s, MZ9_s, MZ12_s and MZ16 to secure the attachment for vertical and oblique observation to the optics carrier (page 32).
- Only usable with 1× achromatic objective.

A detailed description can be found in the user manual M2-266.

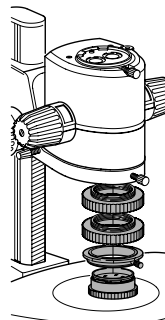

Graticules

- The graticules for length measurements and numbering are fitted in mounts and can be inserted into the eyepieces.
- A special measuring graticule is available for the Leica MZ16 A (see the user manual M2-116).
- A high-precision object micrometer with 50-mm scale, 0.1 mm and 0.01 mm graduation, allows for calibration corresponding to the selected magnification.
- Preferably measure with the microscope carrier AX in vertical position. The measurements are more accurate without the convergence angle in the stereoscopic image.
- Graticules show boundary lines for all film formats.

Inserting the graticule

- ▶ Unscrew the insert at the knurled ring.
- ▶ Clamp the graticule onto the insert with a little bit of pressure. Check for correct seating!
- ▶ Tighten the insert with graticule.
- ▶ Insert the eyepiece.
- ▶ Look into the eyepiece: Align the graticule by turning the eyepiece in the tube and tighten the clamping screw.

A detailed description can be found in the user manual M2-275.

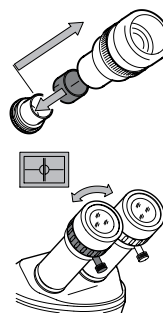

Stages

The \varnothing 120 mm stages can be used in those incident and transmitted-light stands which have a \varnothing 120 mm port.

Gliding stage The gliding stage can be moved in all directions and rotated completely.

- ▶ Place the \varnothing 120 mm gliding stage in the \varnothing 120 mm port and secure it with the eccentric lever.
- ▶ Insert the \varnothing 120 mm glass stage plate or the black/white stage plate.

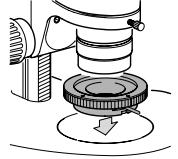

Cup stage

- The cup stage can be inclined as required.
- You can secure objects to its rubberized upper surface with needles.
- The movable holder accepts petri dishes.

- ▶ Place the \varnothing 120 mm support ring in the \varnothing 120 mm port.
- ▶ Place the cup stage on it.

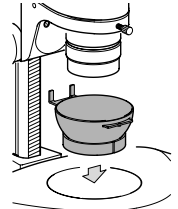

Thermo stages The Leica MATS thermocontrol system is a heating system for microscopes and stereomicroscopes. Leica MATS allows the observation of temperature-sensitive specimens and living cells in biology, medicine and pharmaceuticals under exact temperature conditions.

For details see M2-227-0 instructions for use.

Polarization, transmitted light

The analyzer, in combination with either the rotatable polarization stage or the polarizer on glass stage plate, enables double-refracting materials to be studied. These can include organic crystals, mineral grains, thin sections of rock or bone, polymers, stressed glass, and liquid crystals.

A detailed description can be found in the user manual M2-277.

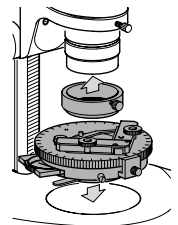

Notes

Tips and hints: What to do if ...

The field of view is partly shadowed.

Remedy:

- Set the interpupillary distance correctly (page 15).
- Locate the eyepoint (page 15).

The image does not stay in focus.

Remedy:

- Fit the eyepieces correctly (page 35).
- Adjust your dioptric settings exactly as described (page 20).

The focusing drifts downwards or can be moved only with difficulty.

Remedy:

- Adjust the ease of movement (pages 16, 29, 31).

If an electrical fault develops, first check the following:

- Is the voltage selector set correctly (bright-field transmitted light stand, page 24; transformer, page 38)?
- Is the power switch on?
- Is the power cable attached correctly?
- Are all connecting cables attached correctly?
- Are the fuses in order?

The image is too dark.

Remedy:

- Turn up the regulating knob high enough (bright-field transmitted light stand, page 24; transformer, page 38).
- Open the double-iris diaphragm of the phototube.

TV, photography

The image on the screen is too dark.

Remedy:

- Adjust the video camera / monitor system in accordance with the directions of the manufacturer.
- Refer to the remedies listed above under "The image is too dark."

Blurred photographs.

Remedy:

- Focus precisely (page 16).
- Adjust your dioptric settings exactly as described (page 20).

Color photographs have a yellow cast.

Remedy:

- Use artificial-light film.
- Turn the regulating knob of the transformer clockwise to the position of maximum voltage (bright field transmitted-light stand, page 24; transformer, page 38).

Care, maintenance

In this section We will show you how to look after your microscope and how to clean it.

We guarantee the quality. You are working with a high-precision, high-performance instrument.

Accordingly, we guarantee the quality of each of our instruments. The guarantee covers all faults in materials and manufacture. It does not, however, cover damage resulting from careless or improper handling.

Please handle your valuable optical instrument with care. It will then fulfill its function with the same precision for decades. Our instruments are known for that!

If, contrary to expectations, your stereomicroscope develops a fault, please call in a specialist – contact your local Leica agent or Leica Microsystems (Switzerland) Ltd, CH-9435 Heerbrugg.

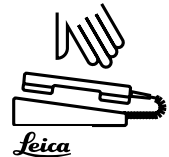

Protect your instruments

- From moisture, vapors, acids, alkalis and corrosive substances, and keep chemicals away from the instruments.
- From improper handling. Never dismantle optical systems or mechanical parts unless instructions for doing so are given in the user manual.
- From oil and grease. Do not grease guide surfaces or mechanical parts.



Cleaning

Dust and dirt will affect the quality of your results.

- Therefore:**
- ▶ Put a dust cover over the instrument during breaks in work.
 - ▶ Use dust caps to protect tube openings, tubes without eyepieces, and eyepieces.
 - ▶ Remove dust with a pneumatic rubber bulb or with a soft brush.
 - ▶ Clean objectives and eyepieces with special optic cleaning cloths and with pure alcohol.
 - ▶ When accessories are not being used, protect them against dust.

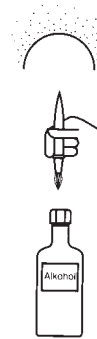

Cleaning polymer components

Some components are made of polymer, or are polymer-coated. They are, therefore, pleasant and convenient to handle. The use of unsuitable cleaning agents and techniques can damage polymers, so always observe the following rules:

Never clean polymers this way



- Never clean them in an ultrasonic bath. The polymer can become brittle and later break.
- Never use corrosive cleaning agents or ones containing acetone.
- Never use solvents for cleaning (except for ethanol and isopropanol).

You can clean polymers harmlessly

- With warm soapy water, wiping down afterwards with distilled water.
- With ethanol (industrial alcohol) and isopropanol.



When cleaning with ethanol or isopropanol, adhere to the appropriate safety regulations.

Calculation

Total magnification and field of view diameter	M_O	Magnification of objective
	M_E	Magnification of eyepiece
	z	Magnification changer position
	q	Tube factor, e.g. 1.5× for coaxial incident light, 45° ErgoTube™ 1.6×
	r	Factor 1.25× if the planachromatic and planapochromatic objectives of the MZ12 ₅ /MZ16 are used on the MS5, MZ6, MZ7 ₅ or MZ9 ₅
	N_{FOV}	Field number of eyepiece. The field numbers are printed on the eyepieces: 10× = 21, 16× = 14, 25× = 9.5, 40× = 6.

Example	M_O	Eyepiece 1×
	M_E	25×/9.5 eyepiece
	z	Zoom position 4
	q	Tube factor 1.5× (because of coaxial illuminator).
	r	Factor 1.25×

Magnification down binocular tube:

$$M_{\text{TOT VIS}} = M_O \times M_E \times z \times q \times r \quad 1 \times 25 \times 4 \times 1.5 \times 1.25 = 187.5 \times$$

Diameter of field of view:

$$\varnothing \text{ OF: } \frac{N_{\text{FOV}}}{M_O \times z \times q \times r} = \frac{9.5}{1 \times 4 \times 1.5 \times 1.25} = 1.3 \text{ mm}$$

Optical data of Leica MS5, MZ6

Objectives		1× Plan 1× Achromat 0.8× Plan*		1× Planapo*		1.6× Planapo* 2× Achromat		0.63× Planapo* 0.8× Achromat		0.5× Plan* 0.63× Achromat		0.32× Achromat		0.5× Achromat		1.5× Achromat	
Eyepieces	Magnification changer position	Working distance (mm)															
		81 Plan 89 Achromat 112 Plan		55 Planapo		19 Planapo 27 Achromat		97 Planapo 112 Achromat		135 Plan 149 Achromat		297 Achromat		187 Achromat		49 Achromat	
		Total magnification	Field diameter (mm)	Total magnification	Field diameter (mm)	Total magnification	Field diameter (mm)	Total magnification	Field diameter (mm)	Total magnification	Field diameter (mm)	Total magnification	Field diameter (mm)	Total magnification	Field diameter (mm)	Total magnification	Field diameter (mm)
10×/21B	0.63	6.3	33.3	7.9	26.6	12.6	16.7	5	42	3.9	53.8	2	105	3.2	65.6	9.4	22.3
	0.8	8	26.3	10	21	16	13.1	6.4	32.8	5	42	2.5	84	4	52.5	11.9	17.6
	1	10	21	12.5	16.8	20	10.5	8	26.3	6.3	33.3	3.1	67.7	5	42	14.9	14.1
	1.25	12.5	16.8	15.6	13.5	25	8.4	10	21	7.8	26.9	3.9	53.8	6.3	33.3	18.7	11.2
	1.6	16	13.1	20	10.5	32	6.6	12.8	16.4	10	21	5	42	8	26.3	23.9	8.8
	2	20	10.5	25	8.4	40	5.3	16	13.1	12.5	16.8	6.3	33.3	10	21	29.9	7
	2.5	25	8.4	31.3	6.7	50	4.2	20	10.5	15.6	13.5	7.8	26.9	12.5	16.8	37.3	5.6
	3.2	32	6.6	40	5.3	64	3.3	25.6	8.2	20	10.5	10	21	16	13.1	47.8	4.4
4	40	5.3	50	4.2	80	2.6	32	6.6	25	8.4	12.5	16.8	20	10.5	59.7	3.5	
16×/14B	0.63	10.1	22.2	12.6	17.8	20.2	11.1	8.1	27.7	6.3	35.6	3.2	70	5	44.8	15	14.9
	0.8	12.8	17.5	16	14	25.6	8.8	10.2	22	8	28	4	56	6.4	35	19.1	11.7
	1	16	14	20	11.2	32	7	12.8	17.5	10	22.4	5	44.8	8	28	23.9	9.4
	1.25	20	11.2	25	9	40	5.6	16	14	12.5	17.9	6.3	35.6	10	22.4	29.9	7.5
	1.6	25.6	8.8	32	7	51.2	4.4	20.5	10.9	16	14	8	28	12.8	17.5	38.2	5.9
	2	32	7	40	5.6	64	3.5	25.6	8.8	20	11.2	10	22.4	16	14	47.8	4.7
	2.5	40	5.6	50	4.5	80	2.8	32	7	25	9	12.5	17.9	20	11.2	59.7	3.8
	3.2	51.2	4.4	64	3.5	102.4	2.2	41	5.5	32	7	16	14	25.6	8.8	76.4	2.9
4	64	3.5	80	2.8	128	1.8	51.2	4.4	40	5.6	20	11.2	32	7	95.5	2.3	
25×/9.5B	0.63	15.8	15	19.7	12.1	31.5	7.5	12.6	18.8	9.8	24.2	4.9	48.5	7.9	30.1	23.5	10.1
	0.8	20	11.9	25	9.5	40	5.9	16	14.8	12.5	19	6.3	37.7	10	23.8	29.9	7.9
	1	25	9.5	31.3	7.6	50	4.8	20	11.9	15.6	15.2	7.8	30.4	12.5	19	37.3	6.4
	1.25	31.3	7.6	39.1	6.1	62.5	3.8	25	9.5	19.5	12.2	9.8	24.2	15.6	15.2	46.6	5.1
	1.6	40	5.9	50	4.8	80	3	32	7.4	25	9.5	12.5	19	20	11.9	59.7	4
	2	50	4.8	62.5	3.8	100	2.4	40	5.9	31.3	7.6	15.6	15.2	25	9.5	74.6	3.2
	2.5	62.5	3.8	78.1	3	125	1.9	50	4.8	39.1	6.1	19.5	12.2	31.3	7.6	93.3	2.5
	3.2	80	3	100	2.4	160	1.5	64	3.7	50	4.8	25	9.5	40	5.9	119.4	2
4	100	2.4	125	1.9	200	1.2	80	3	62.5	3.8	31.3	7.6	50	4.8	149.3	1.6	
40×/6B	0.63	25.2	9.5	31.5	7.6	50.4	4.8	20.2	11.9	15.8	15.2	7.9	30.4	12.6	19	37.6	6.4
	0.8	32	7.5	40	6	64	3.8	25.6	9.4	20	12	10	24	16	15	47.8	5
	1	40	6	50	4.8	80	3	32	7.5	25	9.6	12.5	19.2	20	12	59.7	4
	1.25	50	4.8	62.5	3.8	100	2.4	40	6	31.3	7.7	15.6	15.4	25	9.6	74.6	3.2
	1.6	64	3.8	80	3	128	1.9	51.2	4.7	40	6	20	12	32	7.5	95.5	2.5
	2	80	3	100	2.4	160	1.5	64	3.8	50	4.8	25	9.6	40	6	119.4	2
	2.5	100	2.4	125	1.9	200	1.2	80	3	62.5	3.8	31.3	7.7	50	4.8	149.3	1.6
	3.2	128	1.9	160	1.5	256	0.9	102.4	2.3	80	3	40	6	64	3.8	191	1.3
4	160	1.5	200	1.2	320	0.8	128	1.9	100	2.4	50	4.8	80	3	238.8	1	

MS5: Positions 0.63, 1, 1.6, 2.5, 4

* When using the planachromatic and planapochromatic objectives MZ12s, the magnification is increased by the factor 1.25×.

Objectives		Ergo objective 0.4×–0.63×			
Eyepieces	Magnification changer position	Working distance (mm)			
		63.5 mm		153.5 mm	
		Total magnification	Field diameter (mm)	Total magnification	Field diameter (mm)
10×/21B	0.63	4	52.5	2.6	80.8
	0.8	5	41.2	3.3	63.6
	1	6.4	32.8	4	51.2
	1.25	8	26.3	5	41.2
	1.6	10.2	20.6	6.6	31.8
	2	12.7	16.5	8.2	25.6
	2.5	15.9	13.2	10.3	20.4
	3.2	20.4	10.3	13.2	15.9
	4	25.5	8.2	16.5	12.7
16×/14B	0.63	6.4	35	4	54.6
	0.8	8.2	27.3	5.3	42.3
	1	10.2	22	6.6	33.9
	1.25	12.7	17.6	8.2	27.3
	1.6	16.3	13.7	10.5	21.3
	2	20.4	11	13.2	17
	2.5	25.5	8.8	16.5	13.6
	3.2	32.6	6.9	21	10.6
	4	40.8	5.5	26.3	8.5
25×/9.5B	0.63	10	23.8	6.5	36.5
	0.8	12.7	18.7	8.2	29
	1	15.9	14.9	10.3	23
	1.25	19.9	11.9	12.9	18.4
	1.6	25.5	9.3	16.5	14.4
	2	31.8	7.5	20.6	11.5
	2.5	39.8	6	25.7	9.2
	3.2	51	4.7	32.9	7.2
	4	63.7	3.7	41.2	5.8
40×/6B	0.63	16	14.9	10.4	23
	0.8	20.4	11.8	13.2	18.2
	1	25.5	9.4	16.5	14.5
	1.25	31.8	7.5	20.6	11.7
	1.6	40.8	5.9	26.3	9
	2	51	4.7	32.9	7.3
	2.5	63.7	3.8	41.2	5.8
	3.2	81.5	2.9	52.7	4.6
	4	101.9	2.4	65.8	3.6

Optical data of Leica MZ75, MZ95

Objectives		1× Plan 1× Achromat 0.8× Plan**	1× Planapo**	1.6× Planapo** 2× Achromat	0.63× Planapo** 0.8× Achromat	0.5× Plan** 0.63× Achromat	0.32× Achromat	0.5× Achromat	1.5× Achromat								
Eyepieces	Magnification changer position	Working distance (mm)															
		81 Plan 89 Achromat 112 Plan		55 Planapo		19 Planapo 27 Achromat		97 Planapo 112 Achromat		135 Plan 149 Achromat		297 Achromat		187 Achromat		49 Achromat	
		Total magnification	Field diameter (mm)	Total magnification	Field diameter (mm)	Total magnification	field diameter(mm)	Total magnification	Field diameter (mm)	Total magnification	Field diameter (mm)	Total magnification	Field diameter (mm)	Total magnification	Field diameter (mm)	Total magnification	Field diameter (mm)
10×/21B	0.63	6.3	33.3	7.9	26.6	12.6	16.7	5	42	3.9	53.8	2	105	3.2	65.6	9.4	22.3
	0.8	8	26.3	10	21	16	13.1	6.4	32.8	5	42	2.5	84	4	52.5	11.9	17.6
	1	10	21	12.5	16.8	20	10.5	8	26.3	6.3	33.3	3.1	67.7	5	42	14.9	14.1
	1.25	12.5	16.8	15.6	13.5	25	8.4	10	21	7.8	26.9	3.9	53.8	6.3	33.3	18.7	11.2
	1.6	16	13.1	20	10.5	32	6.6	12.8	16.4	10	21	5	42	8	26.3	23.9	8.8
	2	20	10.5	25	8.4	40	5.3	16	13.1	12.5	16.8	6.3	33.3	10	21	29.9	7
	2.5	25	8.4	31.3	6.7	50	4.2	20	10.5	15.6	13.5	7.8	26.9	12.5	16.8	37.3	5.6
3.2	32	6.6	40	5.3	64	3.3	25.6	8.2	20	10.5	10	21	16	13.1	47.8	4.4	
4	40	5.3	50	4.2	80	2.6	32	6.6	25	8.4	12.5	16.8	20	10.5	59.7	3.5	
5	50	4.2	62.5	3.4	100	2.1	40	5.3	31.3	6.7	15.6	13.5	25	8.4	74.6	2.8	
6*	60	3.5	75	2.8	120	1.8	48	4.4	37.5	5.6	18.8	11.2	30	7	89.6	2.3	
16×/14B	0.63	10.1	22.2	12.6	17.8	20.2	11.1	8.1	27.7	6.3	35.6	3.2	70	5	44.8	15	14.9
	0.8	12.8	17.5	16	14	25.6	8.8	10.2	22	8	28	4	56	6.4	35	19.1	11.7
	1	16	14	20	11.2	32	7	12.8	17.5	10	22.4	5	44.8	8	28	23.9	9.4
	1.25	20	11.2	25	9	40	5.6	16	14	12.5	17.9	6.3	35.6	10	22.4	29.9	7.5
	1.6	25.6	8.8	32	7	51.2	4.4	20.5	10.9	16	14	8	28	12.8	17.5	38.2	5.9
	2	32	7	40	5.6	64	3.5	25.6	8.8	20	11.2	10	22.4	16	14	47.8	4.7
	2.5	40	5.6	50	4.5	80	2.8	32	7	25	9	12.5	17.9	20	11.2	59.7	3.8
3.2	51.2	4.4	64	3.5	102.4	2.2	41	5.5	32	7	16	14	25.6	8.8	76.4	2.9	
4	64	3.5	80	2.8	128	1.8	51.2	4.4	40	5.6	20	11.2	32	7	95.5	2.3	
5	80	2.8	100	2.2	160	1.4	64	3.5	50	4.5	25	9	40	5.6	119.4	1.9	
6*	96	2.3	120	1.9	192	1.2	76.8	2.9	60	3.7	30	7.5	48	4.7	143.3	1.6	
25×/9.5B	0.63	15.8	15	19.7	12.1	31.5	7.5	12.6	18.8	9.8	24.2	4.9	48.5	7.9	30.1	23.5	10.1
	0.8	20	11.9	25	9.5	40	5.9	16	14.8	12.5	19	6.3	37.7	10	23.8	29.9	7.9
	1	25	9.5	31.3	7.6	50	4.8	20	11.9	15.6	15.2	7.8	30.4	12.5	19	37.3	6.4
	1.25	31.3	7.6	39.1	6.1	62.5	3.8	25	9.5	19.5	12.2	9.8	24.2	15.6	15.2	46.6	5.1
	1.6	40	5.9	50	4.8	80	3	32	7.4	25	9.5	12.5	19	20	11.9	59.7	4
	2	50	4.8	62.5	3.8	100	2.4	40	5.9	31.3	7.6	15.6	15.2	25	9.5	74.6	3.2
	2.5	62.5	3.8	78.1	3	125	1.9	50	4.8	39.1	6.1	19.5	12.2	31.3	7.6	93.3	2.5
3.2	80	3	100	2.4	160	1.5	64	3.7	50	4.8	25	9.5	40	5.9	119.4	2	
4	100	2.4	125	1.9	200	1.2	80	3	62.5	3.8	31.3	7.6	50	4.8	149.3	1.6	
5	125	1.9	156.3	1.5	250	1	100	2.4	78.1	3	39.1	6.1	62.5	3.8	186.6	1.3	
6*	150	1.6	187.5	1.3	300	0.8	120	2	93.8	2.5	46.9	5.1	75	3.2	223.9	1.1	
40×/6B	0.63	25.2	9.5	31.5	7.6	50.4	4.8	20.2	11.9	15.8	15.2	7.9	30.4	12.6	19	37.6	6.4
	0.8	32	7.5	40	6	64	3.8	25.6	9.4	20	12	10	24	16	15	47.8	5
	1	40	6	50	4.8	80	3	32	7.5	25	9.6	12.5	19.2	20	12	59.7	4
	1.25	50	4.8	62.5	3.8	100	2.4	40	6	31.3	7.7	15.6	15.4	25	9.6	74.6	3.2
	1.6	64	3.8	80	3	128	1.9	51.2	4.7	40	6	20	12	32	7.5	95.5	2.5
	2	80	3	100	2.4	160	1.5	64	3.8	50	4.8	25	9.6	40	6	119.4	2
	2.5	100	2.4	125	1.9	200	1.2	80	3	62.5	3.8	31.3	7.7	50	4.8	149.3	1.6
3.2	128	1.9	160	1.5	256	0.9	102.4	2.3	80	3	40	6	64	3.8	191	1.3	
4	160	1.5	200	1.2	320	0.8	128	1.9	100	2.4	50	4.8	80	3	238.8	1	
5	200	1.2	250	1	400	0.6	160	1.5	125	1.9	62.5	3.8	100	2.4	298.5	0.8	
6*	240	1	300	0.8	480	0.5	192	1.3	150	1.6	75	3.2	120	2	358.2	0.7	

* Position 6 for MZ95 only

** When using the planachromatic and planapochromatic objectives MZ125, the magnification is increased by the factor 1.25×.

Objectives		Ergo objective 0.4×–0.63×			
Eyepieces	Magnification changer position	Working distance (mm)			
		63.5 mm		153.5mm	
		Total magnification	Field diameter (mm)	Total magnification	Field diameter (mm)
10×/21B	0.63	4	52.5	2.6	80.8
	0.8	5	41.2	3.3	63.6
	1	6.4	32.8	4	51.2
	1.25	8.0	26.3	5	41.2
	1.6	10.2	20.6	6.6	31.8
	2	12.7	16.5	8.2	25.6
	2.5	15.9	13.2	10.3	20.4
	3.2	20.4	10.3	13.2	15.9
	4	25.5	8.2	16.5	12.7
	5	31.8	6.6	20.6	10.2
	6*	38.2	5.5	24.7	8.5
16×/14B	0.63	6.4	35	4	54.6
	0.8	8.2	27.3	5.3	42.3
	1	10.2	22	6.6	33.9
	1.25	12.7	17.6	8.2	27.3
	1.6	16.3	13.7	10.5	21.3
	2	20.4	11	13.2	17
	2.5	25.5	8.8	16.5	13.6
	3.2	32.6	6.9	21	10.6
	4	40.8	5.5	26.3	8.5
	5	51	4.4	32.9	6.8
	6*	61	3.7	39.5	5.7
25×/9.5B	0.63	10	23.8	6.5	36.5
	0.8	12.7	18.7	8.2	29
	1	15.9	14.9	10.3	23
	1.25	19.9	11.9	12.9	18.4
	1.6	25.5	9.3	16.5	14.4
	2	31.8	7.5	20.6	11.5
	2.5	39.8	6	25.7	9.2
	3.2	51	4.7	32.9	7.2
	4	63.7	3.7	41.2	5.8
	5	79.6	3	51.4	4.6
	6*	95.5	2.5	61.7	3.8
40×/6B	0.63	16	14.9	10.4	23
	0.8	20.4	11.8	13.2	18.2
	1	25.5	9.4	16.5	14.5
	1.25	31.8	7.5	20.6	11.7
	1.6	40.8	5.9	26.3	9
	2	51	4.7	32.9	7.3
	2.5	63.7	3.8	41.2	5.8
	3.2	81.5	2.9	52.7	4.6
	4	101.9	2.4	65.8	3.6
	5	127.4	1.9	82.3	2.9
	6*	152.9	1.6	98.8	2.4

Optical data of Leica MZ125, MZ16, MZ16 A

Objectives		1× Plan 1× Planapo		0.5× Plan		0.63× Planapo		0.8× Plan		1.6× Planapo		2× Planapo	
Eyepieces	Magnification changer position	Working distance (mm)											
		60 Plan 55 Planapo		135 Plan		97 Planapo		112 Plan		19 Planapo		15 Planapo	
		Total magnification	Field diameter (mm)	Total magnification	Field diameter (mm)	Total magnification	Field diameter (mm)	Total magnification	Field diameter (mm)	Total magnification	Field diameter (mm)	Total magnification	Field diameter (mm)
10×/21B	0.71	7.1	29.6	3.5	59.1	4.5	47	5.7	37	11.4	18.5	14.2	14.8
	0.8	8	26.3	4	52.5	5.1	41.2	6.4	32.8	12.8	16.4	16	13.1
	1	10	21	5	42	6.4	32.8	8	26.3	16	13.1	20	10.5
	1.25	12.5	16.8	6.3	33.3	8	26.3	10	21	20	10.5	25	8.4
	1.6	16	13.1	8	26.3	10.2	20.6	12.8	16.4	25.6	8.2	32	6.6
	2	20	10.5	10	21	12.8	16.4	16	13.1	32	6.6	40	5.2
	2.5	25	8.4	12.5	16.8	16	13.1	20	10.5	40	5.3	50	4.3
	3.2	32	6.6	16	13.1	20.5	10.2	25.6	8.2	51.2	4.1	64	3.3
	4	40	5.3	20	10.5	25.6	8.2	32	6.6	64	3.3	80	2.6
	5	50	4.2	25	8.4	32	6.6	40	5.3	80	2.6	100	2.1
	6.3	63	3.3	31.5	6.7	40.3	5.2	50.4	4.2	100.8	2.1	126	1.7
	8	80	2.6	40	5.3	51.2	4.1	64	3.3	128	1.6	160	1.3
10	100	2.1	50	4.2	64	3.3	80	2.6	160	1.3	200	1.1	
11.5	115	1.8	57.5	3.7	72.5	2.9	92	2.2	184	1.1	230	0.9	
16×/14B	0.71	11.4	19.7	5.7	39.4	7.2	31.3	9.1	24.6	18.2	12.3	22.8	9.8
	0.8	12.8	17.5	6.4	35	8.2	27.3	10.2	22	20.5	10.9	25.6	8.8
	1	16	14	8	28	10.2	22	12.8	17.5	25.6	8.8	32	7
	1.25	20	11.2	10	22.4	12.8	17.5	16	14	32	7	40	5.6
	1.6	25.6	8.8	12.8	17.5	16.4	13.7	20.5	10.9	41	5.5	51.2	4.4
	2	32	7	16	14	20.5	10.9	25.6	8.8	51.2	4.4	64	3.5
	2.5	40	5.6	20	11.2	25.6	8.8	32	7	64	3.5	80	2.8
	3.2	51.2	4.4	25.6	8.8	32.8	6.8	41	5.5	81.9	2.7	102.4	2.2
	4	64	3.5	32	7	41	5.5	51.2	4.4	102.4	2.2	128	1.8
	5	80	2.8	40	5.6	51.2	4.4	64	3.5	128	1.8	160	1.4
	6.3	100.8	2.2	50.4	4.4	64.5	3.5	80.6	2.8	161.3	1.4	201.6	1.1
	8	128	1.8	64	3.5	81.9	2.7	102.4	2.2	204.8	1.1	256	0.9
10	160	1.4	80	2.8	102.4	2.2	128	1.8	256	0.9	320	0.7	
11.5	184	1.2	92	2.4	115.9	1.9	147.2	1.5	294.4	0.8	368	0.6	
25×/9.5B	0.71	17.7	13.4	8.9	26.8	11.1	21.2	14.2	16.7	28.3	8.4	35.4	6.7
	0.8	20	11.9	10	23.8	12.8	18.6	16	14.8	32	7.4	40	5.9
	1	25	9.5	12.5	19	16	14.8	20	11.9	40	5.9	50	4.8
	1.25	31.3	7.6	15.6	15.2	20	11.9	25	9.5	50	4.8	62.5	3.8
	1.6	40	5.9	20	11.9	25.6	9.3	32	7.4	64	3.7	80	3
	2	50	4.8	25	9.5	32	7.4	40	5.9	80	3	100	2.4
	2.5	62.5	3.8	31.3	7.6	40	5.9	50	4.8	100	2.4	125	1.9
	3.2	80	3	40	5.9	51.2	4.6	64	3.7	128	1.9	160	1.5
	4	100	2.4	50	4.8	64	3.7	80	3	160	1.5	200	1.2
	5	125	1.9	62.5	3.8	80	3	100	2.4	200	1.2	250	1
	6.3	157.5	1.5	78.8	3	100.8	2.4	126	1.9	252	0.9	315	0.8
	8	200	1.2	100	2.4	128	1.9	160	1.5	320	0.7	400	0.6
10	250	1	125	1.9	160	1.5	200	1.2	400	0.6	500	0.5	
11.5	287.5	0.8	143.8	1.7	181.1	1.3	230	1	460	0.5	575	0.4	
40×/6B	0.71	28.4	8.4	14.2	16.9	17.9	13.4	22.7	10.5	45.4	5.3	56.8	4.2
	0.8	32	7.5	16	15	20.5	11.7	25.6	9.4	51.2	4.7	64	3.8
	1	40	6	20	12	25.6	9.4	32	7.5	64	3.8	80	3
	1.25	50	4.8	25	9.6	32	7.5	40	6	80	3	100	2.4
	1.6	64	3.8	32	7.5	41	5.9	51.2	4.7	102.4	2.3	128	1.9
	2	80	3	40	6	51.2	4.7	64	3.8	128	1.9	160	1.5
	2.5	100	2.4	50	4.8	64	3.8	80	3	160	1.5	200	1.2
	3.2	128	1.9	64	3.8	81.9	2.9	102.4	2.3	204.8	1.2	256	0.9
	4	160	1.5	80	3	102.4	2.3	128	1.9	256	0.9	320	0.8
	5	200	1.2	100	2.4	128	1.9	160	1.5	320	0.8	400	0.6
	6.3	252	1	126	1.9	161.3	1.5	201.6	1.2	403.2	0.6	504	0.5
	8	320	0.8	160	1.5	204.8	1.2	256	0.9	512	0.5	640	0.4
10	400	0.6	200	1.2	256	0.9	320	0.8	640	0.4	800	0.3	
11.5	460	0.5	230	1	289.8	0.8	368	0.6	736	0.3	920	0.3	

* Zoom positions 0.71 and 11.5 only for MZ16/MZ16 A

Dimensions of Leica MS5

with incident-light stand

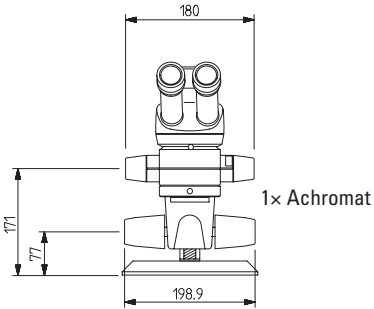

with transmitted-light stand

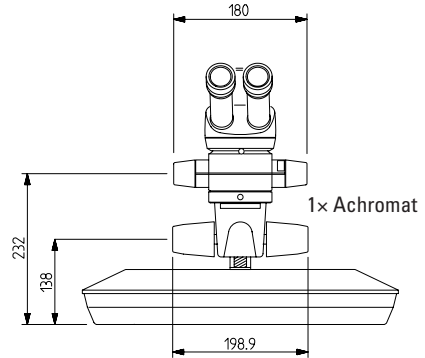

Measurements in mm

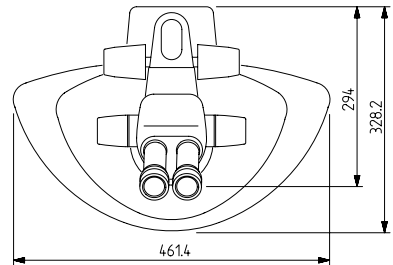
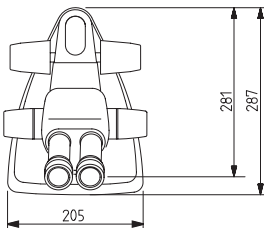
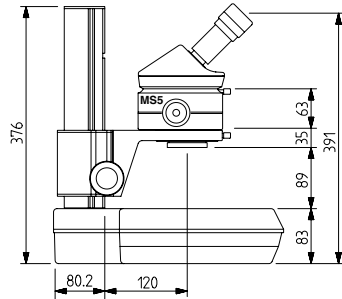
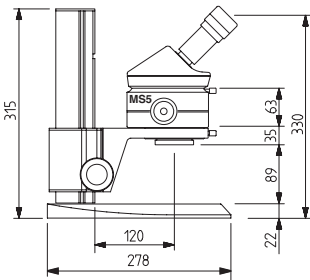

Additional dimensional diagrams involving Leica ErgoModule™ are available from your Leica agency.

Dimensions of Leica MZ6

with incident-light stand

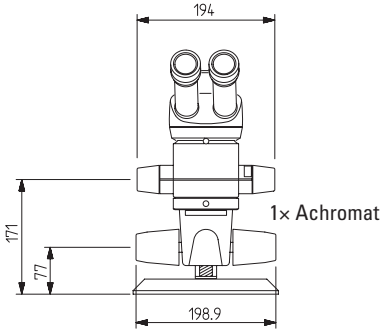

with transmitted-light stand

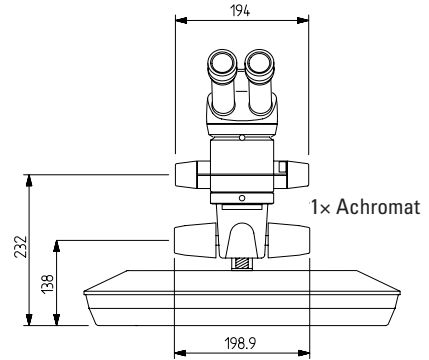

Measurements in mm

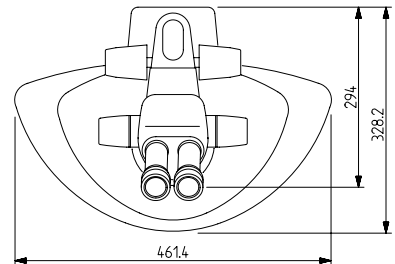
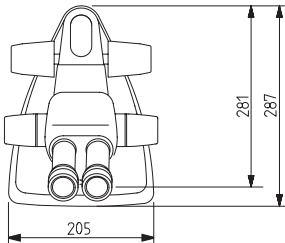
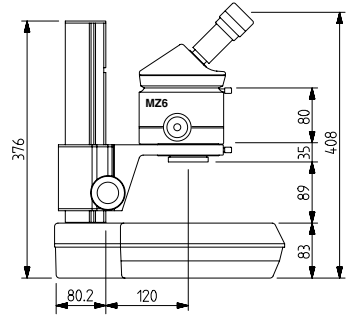
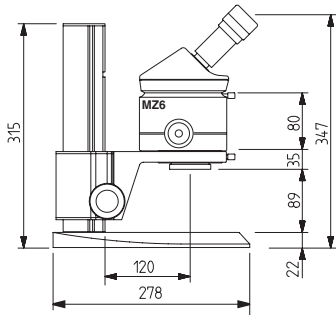

Additional dimensional diagrams involving Leica ErgoModule™ are available from your Leica agency.

Dimensions of Leica MZ75

with incident-light stand

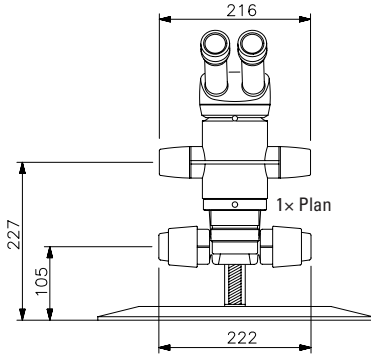

with transmitted-light stand

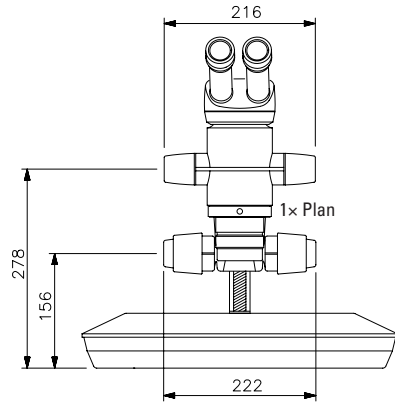

Measurements in mm

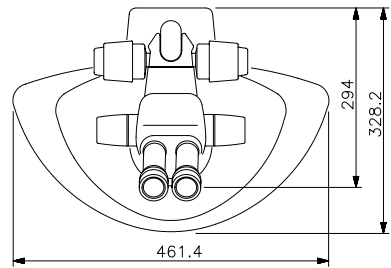
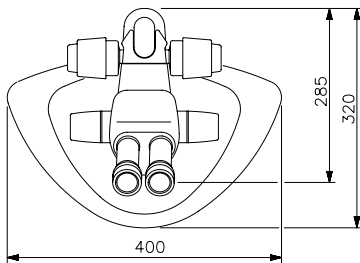
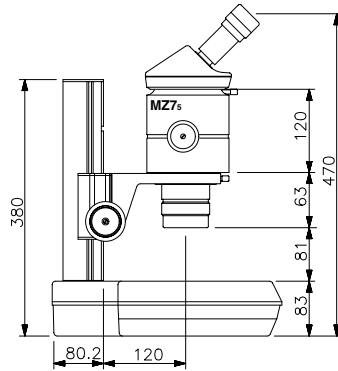
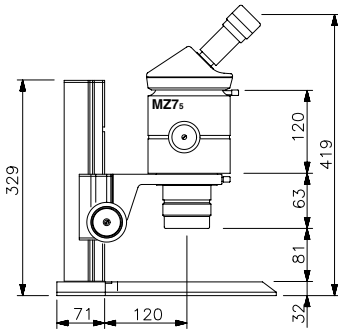

Additional dimensional diagrams involving Leica ErgoModule™ are available from your Leica agency.

Dimensions of Leica MZ95

with incident-light stand

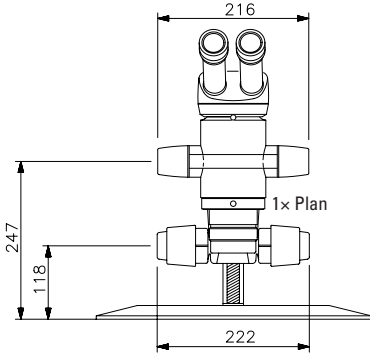

with transmitted-light stand

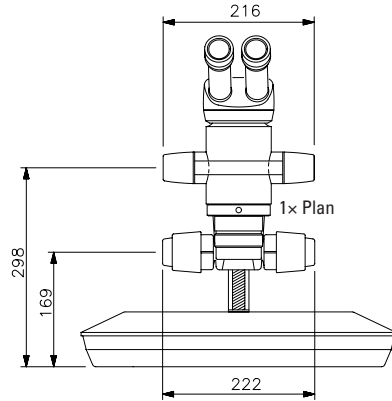

Measurements in mm

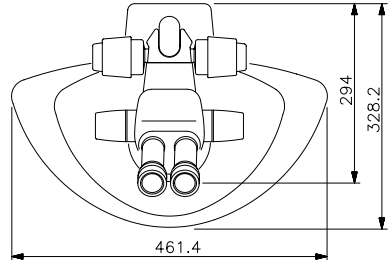
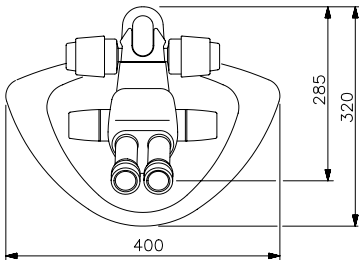
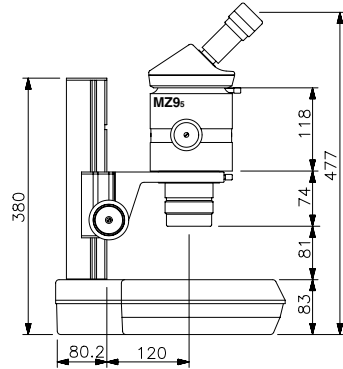
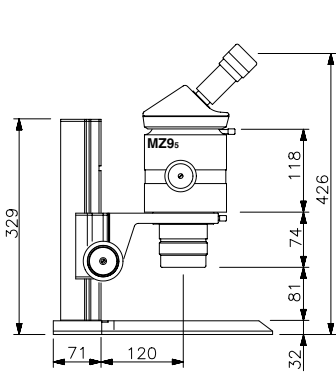

Additional dimensional diagrams involving Leica ErgoModule™ are available from your Leica agency.

Dimensions of Leica MZ125

with incident-light stand

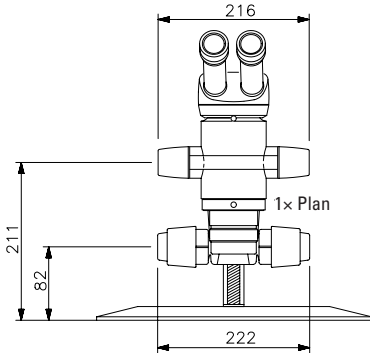

with transmitted-light stand

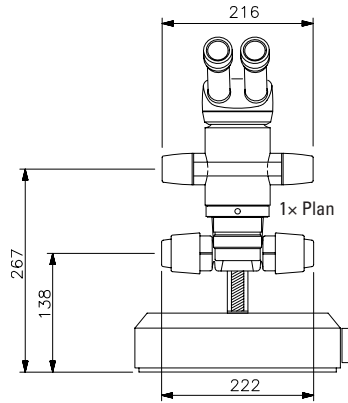

Measurements in mm

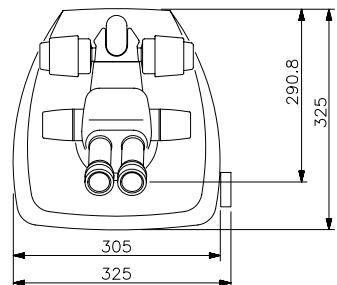
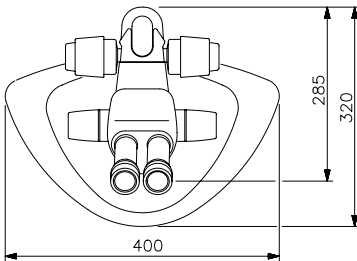
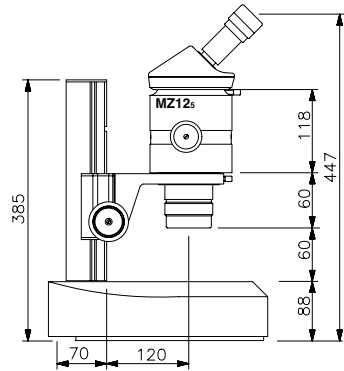
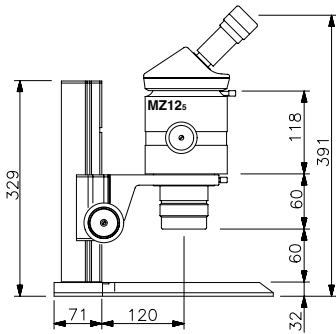

Additional dimensional diagrams involving Leica ErgoModule™ are available from your Leica agency.

Dimensions of Leica MZ16

with incident-light stand

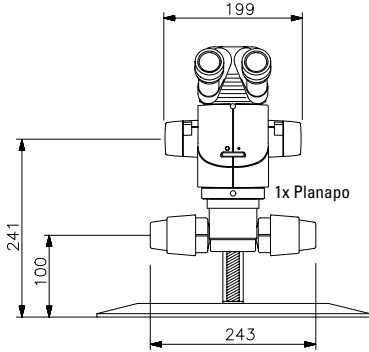

with transmitted-light stand

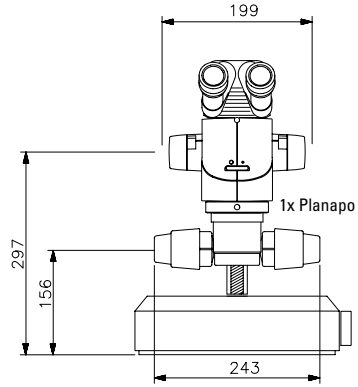

Measurements in mm

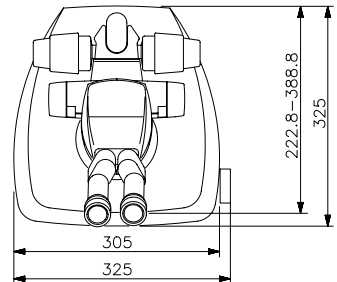
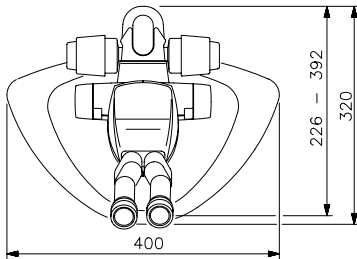
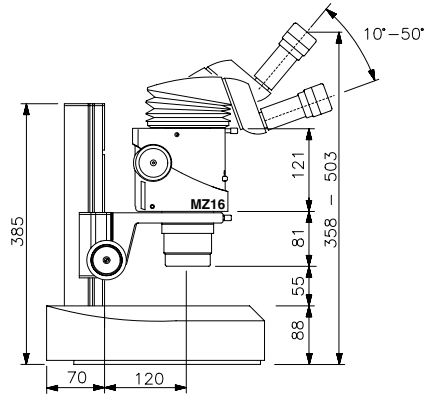
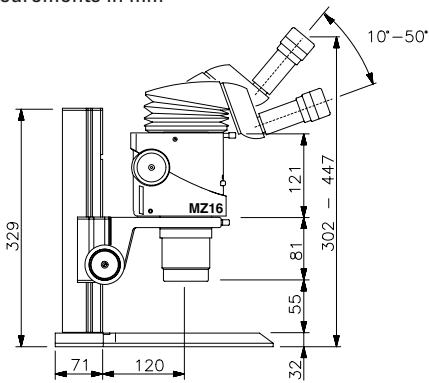

Additional dimensional diagrams involving Leica ErgoModule™ are available from your Leica agency.

Dimensions of Leica MZ16 A

with incident-light stand

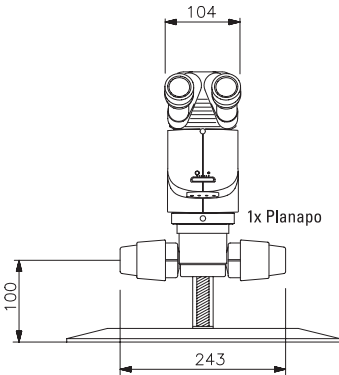

with transmitted-light stand

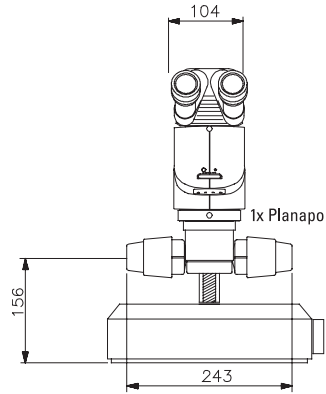

Measurements in mm

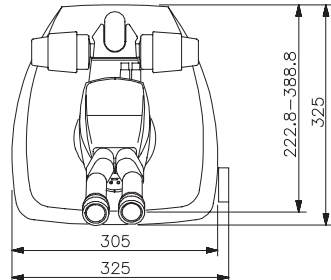
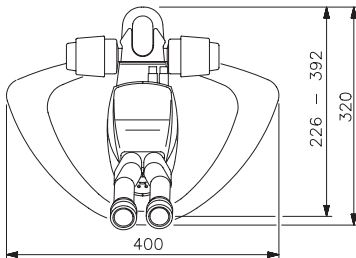
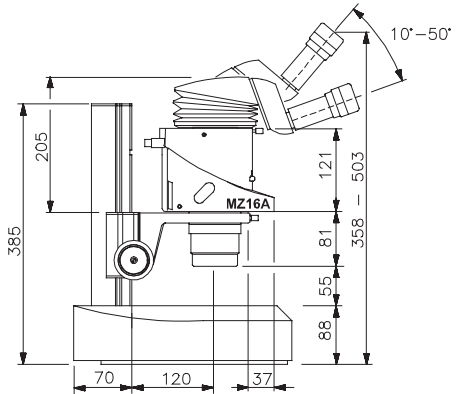
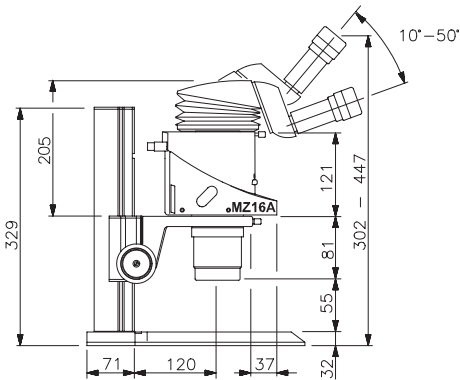

Additional dimensional diagrams involving Leica ErgoModule™ are available from your Leica agency.

Technical data electronic devices

Transmitted-light base 20 W – Technical Data

Type description	Transmitted light base 20 W
Power supply	ES 635 474 incl. potentiometer
Type of bulb	Halogen bulb 6 V/20 W
Socket	Connection for one external incident illumination with a maximum combined loading of 20 W
Operating voltage	Primary voltage: 115 /-230 V, 50/60 Hz Secondary voltage: 7 V 28 VA
Fuses, primary	For 115 V: 315 mA AT / for 230 V: 160 mA AT
Switch positions	Position I: Transmitted light 6 V/20 W Position II: External incident lamp 20 W
Operating environmental conditions: – Ambient temperature – Relative humidity – Atmospheric pressure	+ 10° C ... + 35° C Ambient temperature up to 35° C: 75% 700 ... 1060 hPa
Transport and storage: – Temperature – Relative humidity – Atmospheric pressure	–20° C ... + 52° C 10 ... 95 % (non condensing) 500 ... 1200 hPa
Protection class	Class II
Symbols	Insulation, Protection class II Safety transformer, protection class III SEV mark of conformity, reference number OG 2

Regulating transformer – Technical data

Model code	Transformer MTR38
Outlet	2x Connection for an external incident illuminator up to 20 W
Operating voltage	Primary: 100–240 VAC, 47–63Hz, 1.8 A Secondary: 5.3 V DC–7.5V/40 VA
Primary fuse:	2x T 1A L 250 V
Ambient conditions during operation: – Ambient temperatures – Rel. humidity – Atmospheric pressure	+ 10° C ... + 35° C Up to 35° C ambient temperature: 75% 700 ... 1060 hPa
Transport and storage: – Temperature – Rel. humidity – Atmospheric pressure	–20° C ... + 52° C 10 ... 95 % (non-condensing) 500 ... 1200 hPa
Protection class	IP 30 according to EN 60529/IEC 529
Symbols	CE

Leica Microsystems – the brand for outstanding products

Leica Microsystems' mission is to be the world's first-choice provider of innovative solutions to our customers' needs for vision, measurement, lithography and analysis of microstructures.

Leica, the leading brand for microscopes and scientific instruments, developed from five brand names, all with a long tradition: Wild, Leitz, Reichert, Jung and Cambridge Instruments. Yet Leica symbolizes innovation as well as tradition.

Leica Microsystems – an international company with a strong network of customer services

Australia:	Gladesville, NSW	Tel. +1 800 625 286	Fax +61 2 9817 8358
Austria:	Vienna	Tel. +43 1 486 80 50 0	Fax +43 1 486 80 50 30
Canada:	Richmond Hill/Ontario	Tel. +1 905 762 20 00	Fax +1 905 762 89 37
China:	Hong Kong	Tel. +8522 564 6699	Fax +8522 564 4163
Denmark:	Herlev	Tel. +45 44 5401 01	Fax +45 44 5401 11
France:	Rueil-Malmaison		
	Cédex	Tel. +33 1 4732 8585	Fax +33 1 4732 8586
Germany:	Bensheim	Tel. +49 6251 1360	Fax +49 6251 136 155
Italy:	Milan	Tel. +39 02 57 486 1	Fax +39 02 5740 3273
Japan:	Tokyo	Tel. +81 3 543 596 09	Fax +81 3 543 596 15
Korea:	Seoul	Tel. +82 2 514 6543	Fax +82 2 514 6548
Netherlands:	Rijswijk	Tel. +31 70 41 32 130	Fax +31 70 41 32 109
Portugal:	Lisbon	Tel. +35 1 213 814 766	Fax +35 1 213 854 668
Singapore:		Tel. +65 6 77 97 823	Fax +65 6 77 30 628
Spain:	Barcelona	Tel. +34 93 494 9530	Fax +34 93 494 9532
Sweden:	Sollentuna	Tel. +46 8 625 45 45	Fax +46 8 625 45 10
Switzerland:	Glattbrugg	Tel. +41 44 809 34 34	Fax +41 44 809 34 44
United Kingdom:	Milton Keynes	Tel. +44 1908 246 246	Fax +44 1908 609 992
USA:	Bannockburn/Illinois	Tel. +1 800 248 0123	Fax +1 847 405 0164

and representatives of Leica Microsystems
in more than 100 countries.

In accordance with the ISO 9001 certificate, Leica Microsystems (Switzerland) Ltd, Business Unit Stereo & Microscope Systems has at its disposal a management system that meets the requirements of the international standard for quality management. In addition, production meets the requirements of the international standard ISO 14001 for environmental management.

Leica Microsystems (Switzerland) Ltd
Stereo & Microscope Systems
CH-9435 Heerbrugg

Telephone +41 71 726 33 33
Fax +41 71 726 33 99
www.leica-microsystems.com
www.stereomicroscopy.com

The companies of the Leica Microsystems Group operate internationally in four business segments, where we rank with the market leaders.

● Microscopy Systems

Our expertise in microscopy is the basis for all our solutions for visualization, measurement and analysis of microstructures in life sciences and industry. With confocal laser technology and image analysis systems, we provide three-dimensional viewing facilities and offer new solutions for cytogenetics, pathology and materials sciences.

● Specimen Preparation

We provide comprehensive systems and services for clinical histo- and cytopathology applications, biomedical research and industrial quality assurance. Our product range includes instruments, systems and consumables for tissue infiltration and embedding, microtomes and cryostats as well as automated stainers and coverslippers.

● Medical Equipment

Innovative technologies in our surgical microscopes offer new therapeutic approaches in microsurgery.

● Semiconductor Equipment

Our automated, leading-edge measurement and inspection systems and our E-beam lithography systems make us the first choice supplier for semiconductor manufacturers all over the world.

Leica
MICROSYSTEMS