



Software Reference

easyScan E-Line

(Version 2.1)

TEXT & LAYOUT: R. SUM, PIETER VAN SCHEDEL
ENGLISH: VICKY CONNOLLY

'NANOSURF' AND THE NANOSURF LOGO ARE TRADEMARKS OF NANOSURF AG, REGISTERED AND/OR OTHERWISE
PROTECTED IN VARIOUS COUNTRIES.

© JANUARY 2003 BY NANOSURF AG, SWITZERLAND, PROD.:BT00656, v2.1r0

Table of Contents

Introduction	5
Concept	6
The workspace	6
Controlling the E-STM/AFM hardware	8
Storing measurements	9
Displaying the measurements	10
Evaluating measurements	12
Functional reference	13
Menu File	13
'Save' and 'Save as...'	13
Export ->View as / DataSet as	14
Print, Print Preview	15
Workspace	16
Parameters	17
Menu Panels	17
Approach Panel (E-AFM)	18
Approach Panel (E-STM)	19
Scan Panel	21
Feedback Panel	28
View Panel	30
Spectroscopy Panel	34
Data Info Panel	38
Tool Info Panel	39
Result Panel	39
Menu Tools	40
Measure Length	41
Measure Distance	42
Measure Angle	43
Create a Cross-Section	43
Cut Out Area	44
Calc Line Roughness	45
Calc Area Roughness	46
Correct scan line levels	47
Optical microscope controls (E-AFM)	48
The video switch buttons	48
Menu Options	48
Config Sensor... (E-AFM)	49
Microscope Diagnosis... (E-AFM)	49

Scan Head Calibration...	49
Access codes...	53
Color palette...	53
Auto Adjust Z-Offset	54
Auto Start/Stop Scan	54
Auto Reload Workspace	54
Auto Reload Parameter	54
Config COM Port	55
Simulate microscope	55
Menu 'Window'	56
Menu '?'	56
'About easyScan...'	56

Programs for further data processing 58

Mountains SPM	58
SPIP™	59
Freeware	59

Introduction

This manual is meant as a reference for the easyScan E-Line software. It applies to software version 2.1. This manual consists of two parts. The first part contains an explanation of the concepts behind the software and the user interface. This part should be read entirely to understand the software well. The second part is a reference of all menu commands and dialog functions. It is organised in the same order as they occur in the software menu. This part of the manual can be read bit by bit, when a better understanding of specific functions of the software is needed. Instructions for the day-to-day operation of the easyScan E-AFM and E-STM are given in a separate Manuals, called *E-AFM Operating Instructions* and *E-STM Operating Instructions* respectively.

Concept

The easyScan software has several functions:

- controlling the Nanosurf E-AFM/E-STM hardware,
- storing the measurements and instrument settings in computer memory, on disk or on paper,
- displaying the measurements,
- evaluating the measurements.

These functions can be accessed via the easyScan user interface, which is called 'workspace'. In the following, the workspace will be explained first, then the actual functions of the software will be discussed in more detail.

The workspace

The workspace of the easyScan software consists of three parts:

1. the main window,
2. measurement document windows,
3. control panels.

These parts are shown in the figure *Parts of the easyScan workspace*. The arrangement of these windows and panels, and the way the measurements are displayed can be saved and loaded to a file by the user (see section *Menu File, Workspace* in the reference part of this manual).

The main window is opened as soon as the easyScan software starts. It gives access to the whole functionality of the easyScan software. This is done via the usual windows user interface items, such as a menu, a tool bar and a status bar.

Measurement document windows are windows inside the main window that visually represent previously made measurements. They are created when you decide to keep the current measurement result. The measurement documents are used for storing, loading, printing and evaluation of the measurements. The measurement document is described in more detail in the section *Data representation*.

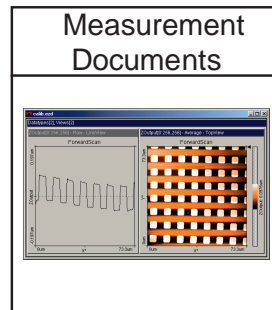
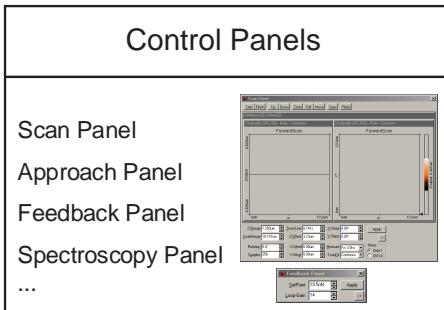
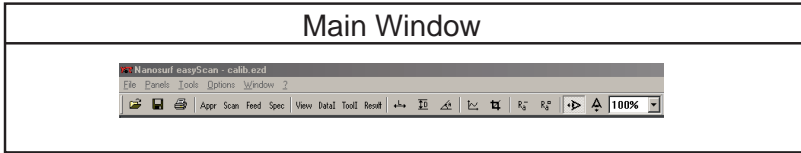



Parts of the easyScan workspace

Control panels are independent dialog windows that give quick access to specific functions of the easyScan software. They can be opened via the menu, or by using their short-cut keys. The Control panels allow you to control the instrument operation (described in section *Measurement*), change the measurement document windows, and perform evaluations.

The control panels allow you to operate the easyScan software by clicking buttons and by changing parameters using input boxes. Most control panels contain **>>**-buttons which give access to less often used parameters. Using **>>**, all parameters are made available. **<<** removes the additional parameters.

The parameters in the control panels can be adjusted in several ways:

- Activate any input by clicking in it with the mouse pointer, or by selecting it with the Tab-key.
- The value of an activated input can be increased and decreased using the up and down arrows on the keyboard. The new value is automatically used after one second.
- The value of a numerical input can also be increased and decreased by clicking the arrow buttons **▲** with the mouse pointer. The new value is automatically used after one second.

- The value of an active numerical input can be entered using the keyboard. The entered value must be confirmed by pressing the 'Enter' or 'Return' key, or by clicking  with the mouse pointer.
- The alternatives in a drop-down menu (e.g.: ) can be selected using the mouse. The selected value must be confirmed by pressing the 'Enter' or 'Return' key, or by clicking  with the mouse pointer.

Sometimes after entering a value, the program changes it to a slightly different value. This happens when the desired setting cannot be performed by the electronics due to the resolution limit of the analog-digital converter. The desired value is automatically changed to the nearest possible value.

Controlling the E-STM/AFM hardware

The easyScan software allows the user to control the E-STM/AFM hardware via several control panels. The settings in the control panels are translated to hardware commands. These commands are either sent to the easyScan E-SPM electronics through the serial port (also COM-port or RS232 port) of your computer, or they are sent to a microscope simulator software module. This simulator module can be used for exploring the easyScan software.

Each of the panels controls a specific instrument function. Some panels control the measurement, others are used to prepare a measurement.

The following panels are used to control the measurements:

- Scan Panel: generates 'topographical' images.
- Spectroscopy Panel: generates force distance curves.
- Feedback Panel: settings for feedback loop parameters.

The 'Approach Panel' is used to control the tip-sample approach before measuring. Finally, with the E-AFM, the toolbar allows you to control the lighting and the (optional) video camera of the optical microscope .

Storing measurements

Data generated by a measurement is stored in the computers memory. The acquired data is grouped and collected to form a measurement document. A measurement document consists of the settings used to obtain the measurement, and measured data (see figure *Measurement document*). The measured data is grouped according to the type of scan with which it was obtained. The measurement document contains one or more of the data types 'ForwardScan', 'BackwardScan', 'Spectroscopy', 'ForwardSpec', 'BackwardSpec', and 'CrossSection' among others.

- The data of the types 'ForwardScan' and 'BackwardScan' is obtained using the 'Scan Panel'.
- The data of the types 'ForwardSpec' and 'BackwardSpec' is obtained using the 'Spectroscopy Panel'. These types consist of one or more spectroscopic measurements, each made in a different position along a line in the xy-plane. The obsolete data type 'Spectroscopy' is identical to 'ForwardSpec'
- The data of the type 'CrossSection' is obtained using the 'Cross-Section' tool.

Each of the data types contains one or more input channels. The channels available depend on the measurement mode, as shown in the table in section *Scan Panel*, parameter 'meas.'. Additional channels may be available with future extensions of the hardware. The names of the input channels can be changed using the dialog 'Scan Head Calibration' (see section *Options* in the Functional Reference part of this manual).

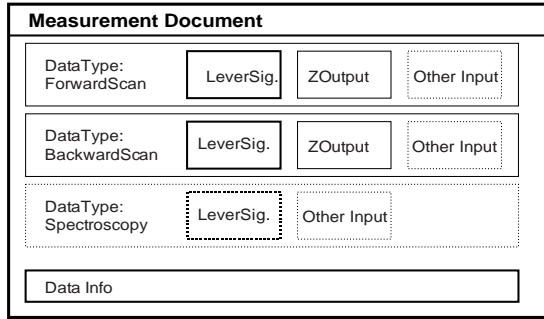

Example of a storage structure of a measurement document

There are several options for exporting the data stored in computer memory: they can be stored on disk in different file formats or they can be printed on paper. All of these storage functions can be accessed via the file menu (see section *Menu File* in the reference part of this manual).

Displaying the measurements

Measurements are displayed in so called 'Views'. These views are found in certain Control panels, and in Measurement document windows. The behaviour of the Measurement document windows is described here, the behaviour of the control panels is in many ways the same.

The name of the file in which the measurement document is stored, is shown at the top of the Measurement document window. Each of the views in the measurement document is connected to one data type and input channel. Other properties of the view are the type of preprocessing performed on the data ('LineMath') and the type of display. Available display types are 'LineView', 'TopView', '3DView' and 'ShadeView'. The displayed line in all LineViews can be selected by dragging the arrow on the right of a TopView- or ShadeView- type display (See figure *Elements of a View*). The easyScan software allows the saving and loading of the settings for the displayed measurement documents and panels (see *Menu File, Workspace* in the reference).

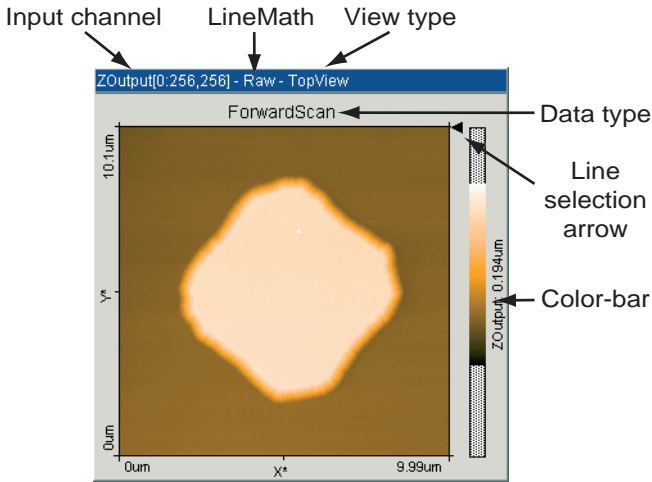

Elements of a View

The 'View Panel' is used to create new views in the active document window, or to modify the properties of the active view. Both Measurement document windows and views are activated by clicking them with the mouse cursor.

The 'Data Info Panel' is used to display the measurement settings of the currently active measurement document.

The functions of the View Panel and the Data Info Panel are described in the section *Panels* of the Functional Reference.

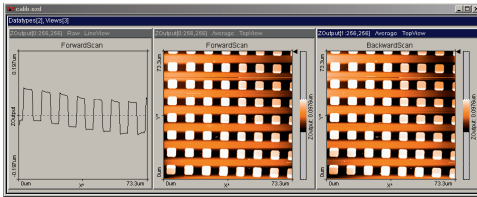

Connects a view to the measured data

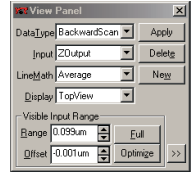

Displays information

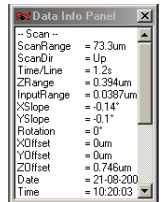
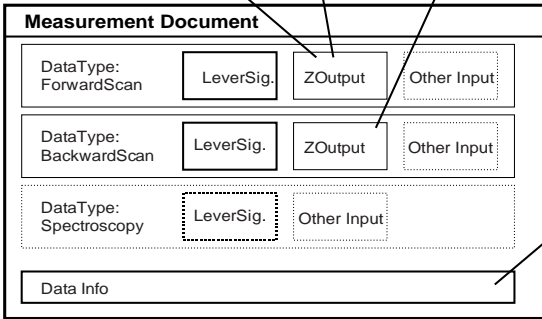

Displaying Measurements: Schematic representation of the data collection of a measurement

Evaluating measurements



Features of the measurements can be evaluated numerically using the evaluation tools. The tools are activated via the corresponding menu item or by the respective button in the tool bar. The tools can be used in all views, both during measurement and off-line. The current status of an evaluation tool is displayed in the 'Tool Info Panel'. More information on the evaluation tools can be found in the functional reference part of this manual.

'SAVE' AND 'SAVE AS...'

Functional reference

In this part of the manual, all the software functions of the easyScan E-Line software are described. The functions are in the same order as they are found in the menu in the main window.

Menu File

Menu entry 'File' contains the items for opening , closing, saving , printing  the measurement documents and for exiting the program. In the following only the special functions are mentioned.

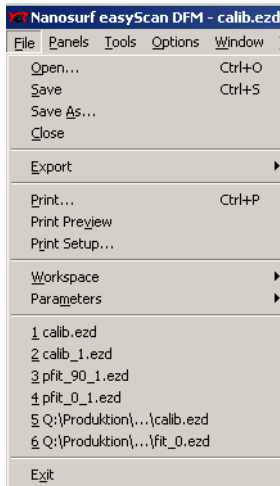

'Save' and 'Save as...'

Using the menu options 'Save' and 'Save as...', you can store measurement documents in the easyScan data format (file extension .ezd).

You can open such a .ezd file by double clicking it with the mouse in the Windows explorer. The 'easyScan' program is started automatically and the data can be analysed. You can also open one or more files by dragging them into the main window.

Export ->View as / DataSet as

With these functions either the active view is saved or the whole active measurement document is saved as a bitmap (.bmp), data file (.dat), plot file (.plt) or comma separated values (.csv) for use in other programs or image processing software (see also chapter 'Programs for further data processing').

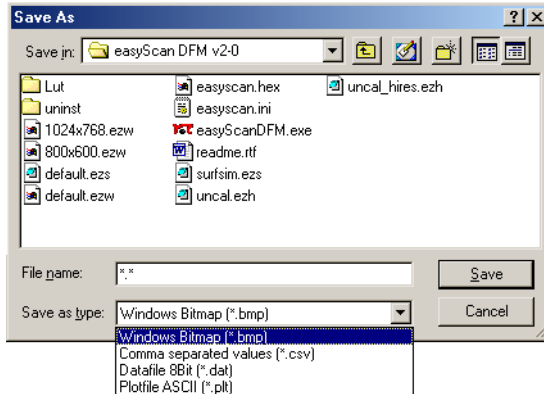

Windows Bitmap (.bmp)

A Windows Bitmap image is suitable for including in documents, e.g. word or image processing software. The exact image as seen on the computer screen will be saved in the file ('screen shot').

Data file 8Bit (.dat)

A binary data file can be processed in image processing software.

This 'binary' data format contains only the measured data. The data is stored consecutively line by line upwards as 8-bit values (0-255). The data is stored using the settings chosen in the 'LineMath' section of the 'View Panel'. If the display mode 'LineView' is selected in the 'View Panel' only the displayed line will be saved.

Plotfile ASCII (.plt)

This is an 'ASCII' text format which contains the measured data as well as a small header with a description of the scan. The data is stored using the setting 'LineMath' in the 'View Panel'. A measurement as a plotfile can be used for detailed data analysis by various mathematics software such as e.g. MathLab or plotted by GnuPlot.

- If 'LineView' is selected as 'Display' in the 'View Panel', only the visualised lines will be stored. Each data point is stored as a pair of floating point numbers on a separate line. The number pairs are separated by a blank character (SPACE).
- If any other view type is selected, all measured values are stored. All values in a data line are stored on a separate line in the text file. An empty line is inserted after every data line. The data lines are stored from the bottom to the top. A small header at the beginning of the first data line contains the names of the channel and frame, as well as x-, y-, and z-ranges with their physical units.

If the actual data is stored using the function 'Export->DataSet as..', then every 'View' in the measurement document is stored in the export file consecutively. Whereby the settings as described above are used.

With the 'binary' format the blocks of data from each 'View' are stored directly one behind the other.

With the 'ASCII' text format the blocks of data for each 'View' are separated by two empty lines.

Comma separated values (.csv)

This format stores all the measured data as a matrix of floating point numbers in ASCII format separated by a 'comma' and 'SPACE' character. This enables easy data exchange with commonly used spread sheet and database applications.

Print, Print Preview

Prints the actual measurement document together with the values shown in the 'Data Info Panel'.

The print Preview shows what the printed image will look like on screen. The following figure shows a print preview of a typical measurement. In addition to all the views, further information is provided on the print-out.

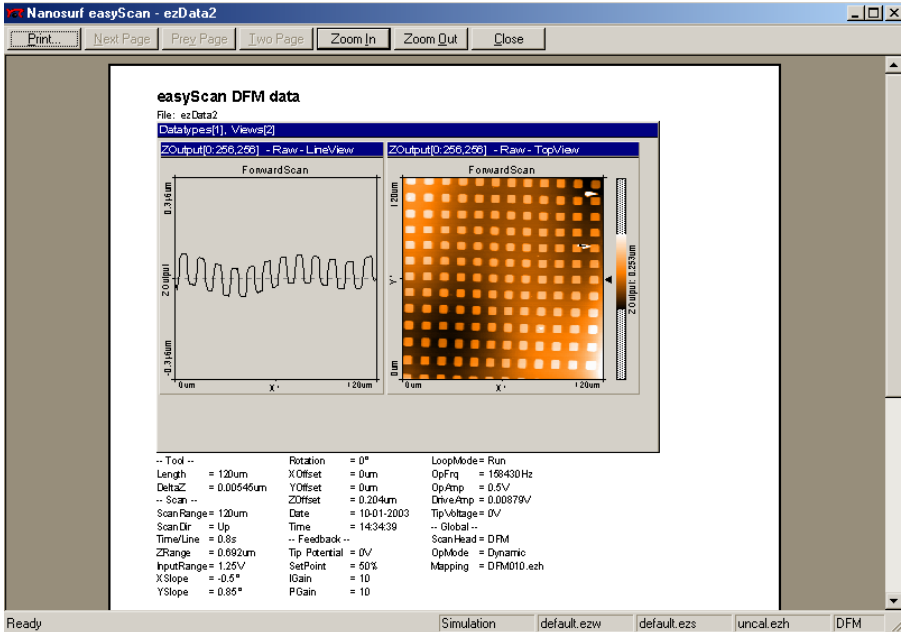

Workspace

When the 'easyScan' program is started some of the panels appear at predefined places on the computer's screen, and the measurement displays contain certain views. This arrangement of the 'workspace' is stored in the configuration file 'Default_E-STM.ezw' or 'Default_E-AFM.ezw' by default. The location of the settings files on the hard-disk depends on the operating system you use.

Using 'Save as...', you can save your own arrangement of the panels under another name if desired.

Using 'Load', you can load predefined arrangements of the panels.

Important!

With 'Save' you directly overwrite the original configuration file 'Default_E-STM.ezw' or 'Default_E-AFM.ezw' with the current arrangement of the panels .

If the default file is missing, the 'easyScan' main window remains empty after program start. If a panel is opened it opens in the centre of the main window.

Parameters

All the panels parameters are stored in a configuration file with the extension '.ezs'. When the E-Line software is started, default values are loaded which are stored in the file named 'Default_E-STM.ezs' or 'Default_E-AFM.ezs. The location of the settings files on the hard-disk depends on the operating system you use.

Using 'Save as...', altered settings can be stored under a new file name. These settings can be loaded by 'Load'.

Important!

With 'Save', you directly overwrite the original configuration file 'Default_E-STM.ezs' or 'Default_E-AFM.ezs' with your current settings.

If the default file is missing, the program inserts default values for all parameters.

Menu Panels

A panel can be selected using the menu, the tool bar or using the 'Ctrl'-key and its corresponding function key.

anosurf easyScan DFM - calib.ez	
Panels	Tools Options Window
Approach Panel	Ctrl+F1
Scan Panel	Ctrl+F2
Feedback Panel	Ctrl+F3
Spectroscopy Panel	Ctrl+F4
View Panel	Ctrl+F5
Data Info Panel	Ctrl+F6
Tool Info Panel	Ctrl+F7
Result Panel	Ctrl+F8

Appr	Scan	Feed	Spec	View	DataI	ToolI	Result
------	------	------	------	------	-------	-------	--------

Note that the grouping of the tool bar buttons corresponds to the grouping of the function keys on the keyboard.

When a panel is selected it is opened, or it is brought into the foreground if it is hidden behind other windows.

Approach Panel (E-AFM)

The tip to the sample approach is operated using the 'Approach Panel'.

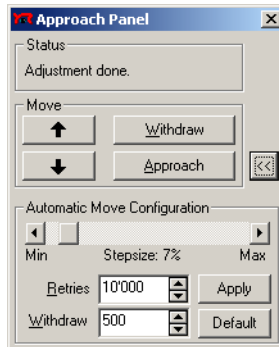



Status

Monitors the current status of the sensor approach.

Move

The following four buttons control the sensor approach drive:

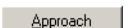
- : drives the sensor away from the sample at maximum speed until the button is released.
- : drives the sensor towards the sample at maximum speed until the button is released.
- : retracts the sensor from the sample by a predefined time.
- : starts the automatic tip to sample approach until the force set-point, set in the feedback panel, is detected.

APPROACH PANEL (E-STM)

Automatic Move Configuration

Stepsize: The speed of the motor during the automatic approach can be adjusted using the slider.

Important!

If the tip to sample approach is too fast, the tip or the sample surface can be damaged. It is therefore recommended to use make 'Stepsize' as small as possible. However, the motor will not move when 'Stepsize' becomes too small (at a 'Stepsize' of approximately 3%).

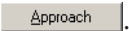
Retries: The 'Retries' value defines how long the maximum the automatic approach runs after clicking .

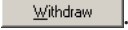
Withdraw: The 'Withdraw' value defines how long the tip is retracted from the sample after clicking .

Approach Panel (E-STM)

The tip to the sample approach is operated using the 'Approach Panel'. This is used to obtain a precise and reproducible sample to tip approach.

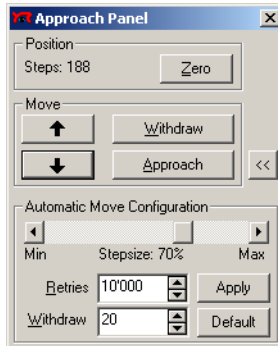
**Position**

The Z-position of the motor is monitored by the number of steps performed.

Steps: shows the number of steps taken.

: resets the 'steps' to zero.

Move

The following four buttons control sample holder's motor:

: drives the sample holder away from the tip with the maximum step size until the button is released.

: drives the sample holder towards the tip with the maximum step size until the button is released.

: withdraws the sample from the tip by a predefined number of steps.

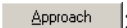
: approaches the sample surface toward the tip until the tunneling current set-point, set in the feedback panel, is detected.

At the start of the approach, the tip is retracted. The sample is moved one step towards the tip by the piezo motor. The tip is then moved towards the sample until the desired tunneling current is detected. If the current is not detected in the maximum tip position, the tip is retracted again and the sample is moved another step towards the tip. This procedure is repeated until the desired tunneling current flows between tip and sample or the maximum number of steps have been reached. The Z-Offset is reset to zero by starting 'Approach'.

Automatic Move Configuration

Stepsize: The stepsize of the approach motor during the automatic approach can be adjusted using the slider.

Important!

- The step size of the piezo motor may vary slightly from device to device and also depends strongly on the friction between slider and the guide bars on which the slider is moved. Therefore keep always both parts clean (See section *Maintenance* in the *Operating Instructions*).

SCAN PANEL

- If the step size of the tip to sample approach is too large, the tip can be damaged. It is therefore recommended to use make 'Stepsize' as small as possible. However, the motor will not move when 'Stepsize' becomes too small (at a 'Stepsize' of approximately 50%).

Retries: The 'Retries' value defines the maximum number of steps the automatic approach runs after clicking

 Approach

Withdraw: The 'Withdraw' value defines the number of steps the sample is retracted from the tip after clicking

 Withdraw

Scan Panel

The 'Scan Panel' is the control centre of the instrument. Here the most important measuring parameters are set and the acquired data is displayed. The whole scan panel is divided in three parts (see figure *Scan Panel*): scan control, data views and parameter fields.

After starting the program (with the default workspace) two areas appear in the centre of the 'Scan Panel' in which the measured data are displayed. The data can be viewed in several ways simultaneously depending on the setting in 'View Panel'.

The 'Scan Panel' can be changed in size. This enables the representation of any number of data views even during scanning. The size of the 'Scan Panel' is changed using the mouse pointer. New views are added to the 'Scan Panel' using  New in the 'View Panel'. The attributes of the new views are defined using the 'View Panel'.

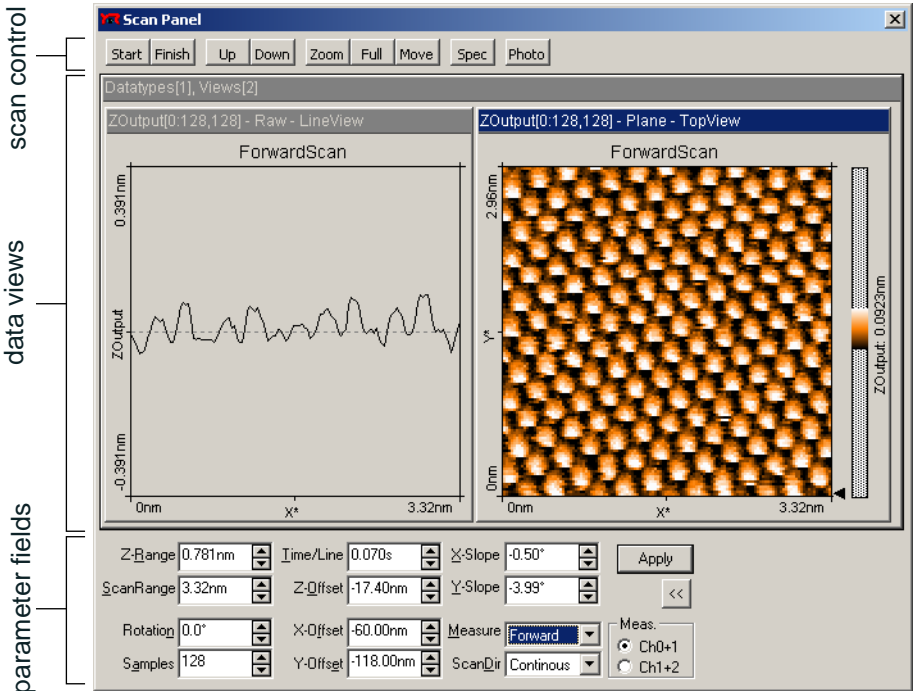

The scan panel

We recommend having at least two displays, one a section ('Line View') of the scan surface (showing the actual scan line) and one topographical ('Top View').

Start/Stop, Up, Down

In the upper part of the 'Scan Panel' are the buttons to control the scan.

Start / Stop : **Start** starts a measurement and then changes to **Stop** . This button can then used to abort the measurement immediately.

Finish : After using **Finish** the measurement stops when the bottom (or top) of the image has been reached.

Up / Down : With **Up** the image is scanned from the bottom to top, with **Down** it is scanned from the top to the bottom.

SCAN PANEL

If a scan has been started using **Up** or **Down** the measurement stops automatically after one full image .

Zoom

With **Zoom** a smaller area can be measured in more detail. The area of the zoom is defined by dragging the mouse pointer over an area in a ‘TopView’ while holding down the left mouse button. Once an area is defined, it can be resized by dragging one of its corners, and moved to the desired position by dragging its centre point.

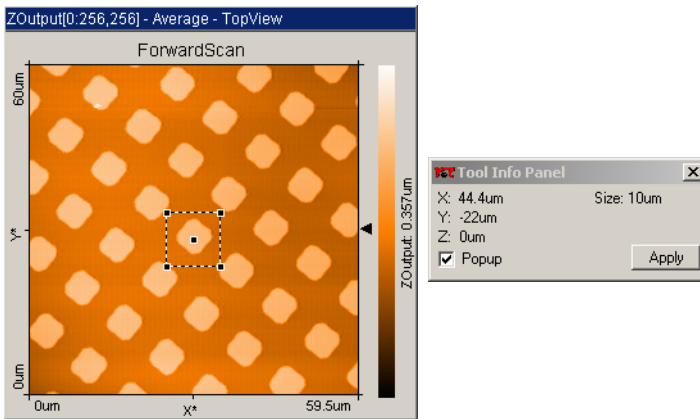

The ‘Tool Info Panel’ shows the size and position of this new area and the cursor position. A double click with left mouse button in the view, or clicking **Apply** in the tool info panel, modifies the parameters ‘ScanRange’, ‘X-, Y-, Z-Offset’ in ‘Scan Panel’ accordingly. When the zoom function is active it can be aborted either by clicking **Zoom** again or by clicking with the right mouse button.

If just a single mouse click is performed in the active ‘View’, a square 33% of the full area is generated.

Full

Full returns the parameters ‘ScanRange’ and Z-range to the largest possible values, and the ‘X-’, ‘Y-’, and ‘Z-Offset’ to zero.

Move

With **Move** you can move the image. An interesting corner can thus be moved to the centre of the picture. The change in the position is indicated by an arrow. This arrow is defined by pressing the left mouse button and dragging the mouse pointer along a line then releasing it. The image is moved from its original position to the newly chosen one by double clicking, or clicking **Apply** in the 'Tool Info Panel'. The move function can be aborted either by using **Move** again or by clicking with the right mouse button. A single mouse click in the active 'View' produces an arrow from the actual pointer position to the centre of the 'View'.

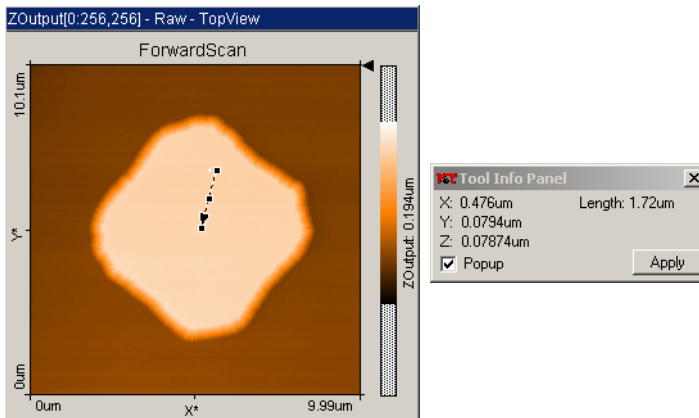

Spec

By using **Spec** the current measurement is interrupted and the actual data is transferred to the 'Spectroscopy Panel', which opens automatically. It is advisable to use **Finish** to complete the current scan before starting the spectroscopy measurement.

Force-distance, or tunneling current-distance experiments are performed using the 'Spectroscopy Panel'.

SCAN PANEL

Photo

Clicking **Photo** captures the current measurement displayed in the 'Scan Panel' in a measurement document, and displays it in a separate window. The scanning continues automatically.

If **Photo** is clicked during the scan, a copy is generated when the actual measurement is finished. During the scan the button remains pressed. The capture process is cancelled by clicking **Photo** a second time.

To capture an image without waiting for the scan to be completed, stop the scanning by clicking **Stop**. The image can then be captured immediately by clicking **Photo**.

The measurement documents are labelled automatically with increasing numbers (i.e. ezData1.ezd, ezData2.ezd, ...). When leaving the program you will be asked if you want to save the unsaved measurement documents.

Standard parameters

Z-Range	0.313um	Time/Line	0.500s	X-Slope	0.00°	Apply
ScanRange	10.16um	Z-Offset	0.00um	Y-Slope	0.00°	

Z-Range/InputRange: determines the range of possible data values of the currently active view of the scan panel. When the active view displays height data, the name of the input is 'Z-Range', otherwise it is 'InputRange'. When the value of 'Z-/InputRange' is reduced, the signal is amplified. This allows observing small features on a surface .

ScanRange: fixes the scan size in x and y direction where (x=y). The value is doubled or halved when using .

Time/Line: sets the time taken to acquire a data line.

The plane on which the tip is scanned (scan-plane) can be aligned to the surface of the sample using the next three parameters (also see schematics):

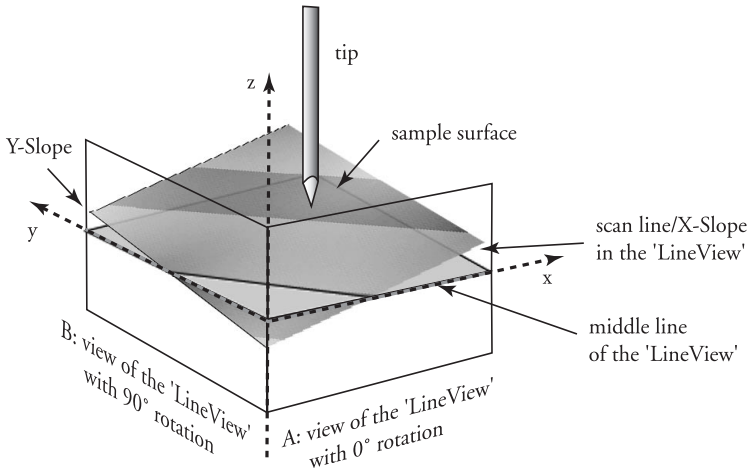

Z-Offset: shifts the scan-plane in z-direction. This parameter can only be used when 'Auto adjust z-Offset' in the 'Options' menu is turned off.

X-slope: A positive value tilts the x-axis of the scan-plane counter-clockwise.

Y-slope: tilts the y-axis of the scan-plane counter-clockwise (when viewed at 90° rotation).

When the scan-plane is correctly aligned, more accurate measurements can be made, because a smaller z-Range can be used. In addition, the error signal of the height feedback circuit is smaller because it does not have to compensate for the scan-plane.

Advanced parameters



If the advanced parameters are not available, they can be opened by clicking .

Rotation: sets the clockwise rotation angle of the scanned area.

Samples: sets the number of measured data points per line.

SCAN PANEL

The scanned area can be shifted by changing the x-/y-offset. The values are always relative to the centre of the entire scan range:

X-Offset: sets the centre position of the measured area in x-direction.

Y-Offset: sets the centre position of the measured area in y-direction.

Measure: The options are 'Backward', 'Forward' or 'Forw. & Backw.'.

- 'Forward': data is acquired and stored during forward scan only (left to right in the image).
- 'Backward': data is acquired and stored during backward scan only (right to left in the image).
- 'Forw.&Backw.': data is acquired and stored during both forward and backward scan.

ScanDir: The options are 'Continuous', 'Cont.Up' or 'Cont.Down':

- 'Continuous': data is acquired and displayed from bottom to top and vice versa.
- 'Cont.Up': data is acquired and displayed from bottom to top.
- 'Cont.Down': data is acquired and displayed from top to bottom.

Meas. Determines which input channels are measured. When the option 'Ch0+1' is selected, logical input channel 0 and 1 are measured, when the option 'Ch1+2' is selected, input 1 and 2 are measured. Usually, only 'Ch0+1' is available, unless the second channel option is installed (see section *Options, Access codes...*). The mapping of the physical input channels on the logical channels 0..2 depends on instrument, as given in the table below. For more information of the signal mapping see the section *Menu options, Scan head calibration*.

	Channel 0	Channel 1	Channel 2
E-AFM	LeverSig	ZOutput	User Signal (optional)
E-STM	Current	ZOutput	User Signal (optional)

Feedback Panel

To scan the sensor across the sample's surface the distance between tip and sample must be controlled. In Atomic Force Microscopy the control parameter is the interacting force between tip and sample, in Scanning Tunneling Microscopy it is the tunneling current.

The parameters of the feedback loop and the feedback force/current are set in the 'Feedback Panel':

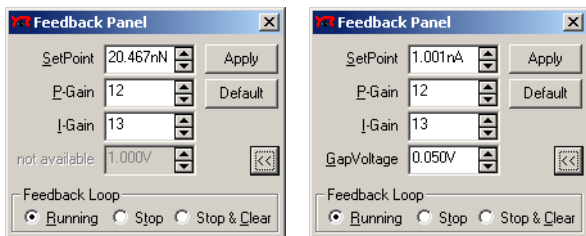

Feedback Panel: Setting the feedback loop parameters, left: for E-AFM, right: for E-STM

- SetPoint:** sets the working point for the feedback loop. Depending on the instrument, this will be a force (E-AFM), or a current (E-STM).
- P-Gain:** sets the speed of the proportional feedback loop. Increasing P-Gain by one doubles the speed of the feedback loop.
- I-Gain:** sets the speed of the integrative feedback loop. Increasing I-Gain by one doubles the speed of the feedback loop.

If the Gain is set to 0, the feedback loop is switched off. When the Gain is set to 16, it has maximum speed. If the gain is too low, the feedback loop will not follow the surface fast enough. Thus, the image will not be

as sharp as it could be. If the gain is too high, the feedback loop will overshoot and may start to oscillate. Thus, the image will contain many measurement artifacts.

TipVoltage (E-AFM): sets the potential to be applied to the tip. The usable voltage range is between -10V and +10V. Note that the sample has to be electrically connected to the instrument chassis ground for accurate measurements.

GapVoltage (E-STM): sets the voltage of the tunneling gap between tip and sample [V]. A positive 'GapVoltage' means that the tip has a positive potential relative to the sample's surface and hence the electrons tunnel from the sample to the scanning tip.

Default :

restores the default values. These settings can be used to measure the microstructure sample with the E-AFM, and graphite with the E-STM.

Advanced options

Running: the feedback loop of the Z-distance controller is active.

Stop: turns off the Z-distance controller. The tip is fixed in the actual Z-position relative to the scan-plane defined by X- and Y-Slope.

Stop & Clear: turns off the Z-distance controller. The tip's Z-position is set to the actual 'Z-Offset' position relative to the scan-plane defined by X- and Y-Slope.

Important:

If the z-offset is much lower than the current position of the tip, or the scan range contains large height differences, turning off the feedback (and clearing it) will result in the tip crashing into the sample, damaging the tip!

View Panel

The way the data is represented in a 'View' can be controlled by the 'View Panel' attributes. The settings either refer to the actual active view (highlighted) in the data display, or to a new view. It is possible to show the same data in different ways using the 'View Panel' settings.

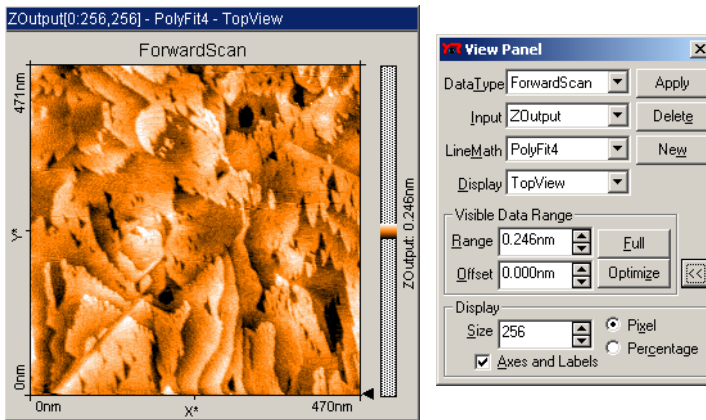

View Panel: setting of the view parameters

The following buttons control the creation and modification of the views.



applies the current settings to the active view.



uses the current settings to create a new view in the active measurement document. The 'Scan Panel', or the measurement document may have to be resized to see all 'Views'.



removes the active display.

Data Type:

depending on what is being measured or saved in a measurement document (see *Scan Panel*, Parameter 'Measure'), the data type that is shown can be chosen here: 'ForwardScan', 'BackwardScan', 'ForwardSpec', 'BackwardSpec', or 'CrossSection'.

Input:

indicates which physical input channel is displayed.

- 'ZOutput': the movement of the Z feedback loop.
- 'LeverSig': the cantilever deflection signal (E-AFM).

- ‘Current’: the tunneling current (E-STM).
- ‘User Signal’: a user definable input signal. (Optional)

The available input channels signals depend on the measured logical input channels and on the currently selected data type (see *Scan Panel*, Parameter ‘Meas.’). Note that the names of the physical channels can be changed in the ‘Scan Head Calibration’ dialog.

LineMath:

defines the processing of data before it is displayed:

- ‘Raw’: raw data without any processing.
- ‘Average’: an average is subtracted from data points.
- ‘Plane’: an inclined plane is subtracted from data.
- ‘Derive’: difference between two successive data points (derivative).
- ‘Parabola’: a second order polynomial is subtracted from data.
- ‘PolyFit4’: a fourth order polynomial is subtracted from data.

Display:

sets the display mode:

- ‘LineView’: data is displayed as x-z diagram (-> contour line). Points outside the Data Range are displayed in red.
- ‘TopView’: data is encoded in gray scale values in xy-plane (-> ‘topography’).
- ‘3D-view’: data is shown as a 3-dimensional representation in a parallel perspective.
- ‘ShadeView’: creates a three dimensional impression of the surface with lighting from the left. This is achieved by combining the topography with its derivative

- ‘DualLineView’: both the Forward and the Backward data (when available) are displayed as in the ‘LineView’. The line of the data type selected in ‘DataType’ is black, the other type is grey.

When the display mode ‘LineView’ is selected, the Z-Range is automatically set to full range.

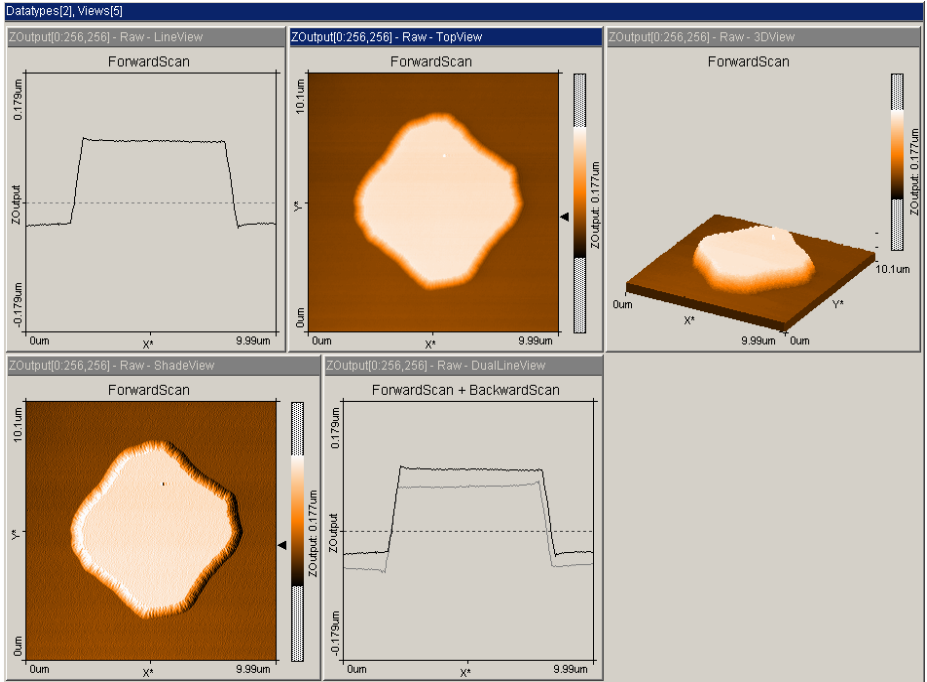

Data represented using different display modes

Visible Data Range:

The grey scale of an image is controlled by the settings in the ‘Visible Data Range’ section. The actual colour mapping is represented as a color-bar in the appropriate ‘Top View’ window.

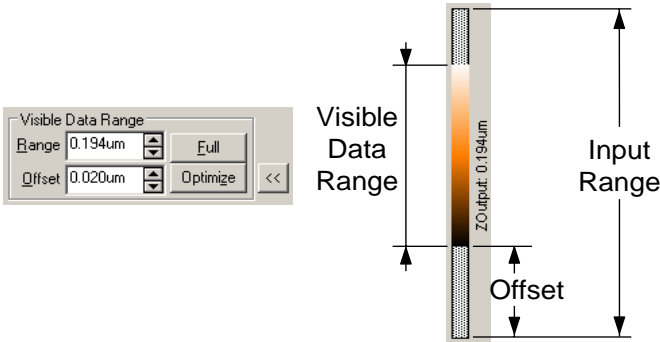

- Range:** affects the 'contrast' of the image.
- Offset:** affects the 'brightness' of the image.
- Full :** expands the visible data range to the full input range.
- Optimize :** uses a histogram of the measured data to set the optimum range and offset for the active view.

Advanced options

The amount of information in a 'View' is controlled by the attributes in the 'Display' section:



- Size:** Defines the size of the active view.
- Pixel:** If selected then the value in 'Size' indicates the image size in pixels. The number of pixels should be an integer multiple of the value 'Samples' (measured points) in 'Scan Panel' or 'Spectroscopy Panel' in order to avoid interpolation which could lead to imaging faults (Moiré pattern)
- Percentage:** If selected then the value in 'Size' indicates the number of pixels per measured point in percent: recommended is 100%, 200% or 300%.

Axes and labels: With this check box the labels in 'Views' and the color-bar in 'TopView' window, can be switched on and off.

Spectroscopy Panel

The 'Spectroscopy Panel' is used to perform spectroscopic measurement sequences. In a spectroscopic measurement, the input channels are measured as a function of a modulated parameter. This modulated parameter can be the z-distance to the sample, or the tip-sample voltage difference. (Note that you must electrically connect the sample to the chassis ground of the instrument to apply a tip-sample voltage difference .) The measured parameter can be any available input channel. Examples of a spectroscopy measurement are force/distance curves with the E-AFM, or current/voltage curves with the E-STM. The accuracy of the spectroscopic measurements can be increased by averaging the measurement results of several consecutive modulations.

A spectroscopic measurement sequence consists of one or more spectroscopic measurements of the same type, measured on a user defined number of points along a line in the xy-plane. A point measurement is made if the number of points is one. The measurement sequence is carried out as follows:

1. The tip is moved with active feedback to the start of the line.
2. The feedback loop is switched off.
3. A spectroscopic measurement is recorded.
4. The feedback loop is turned on again.
5. The tip is moved to the next point on the line in the xy-plane.

Steps 2.-5. are repeated for each points on the line.

The spectroscopy panel is divided in three parts: scan control, data views and parameter fields. When the spectroscopy panel is activated from the 'Scan Panel', a new measurement document is created, and the last measured scan is transferred to the spectroscopy panel. When activated using the menu item or the function key 'F4' or clicking  in the tool bar, the panel is opened without data transfer.

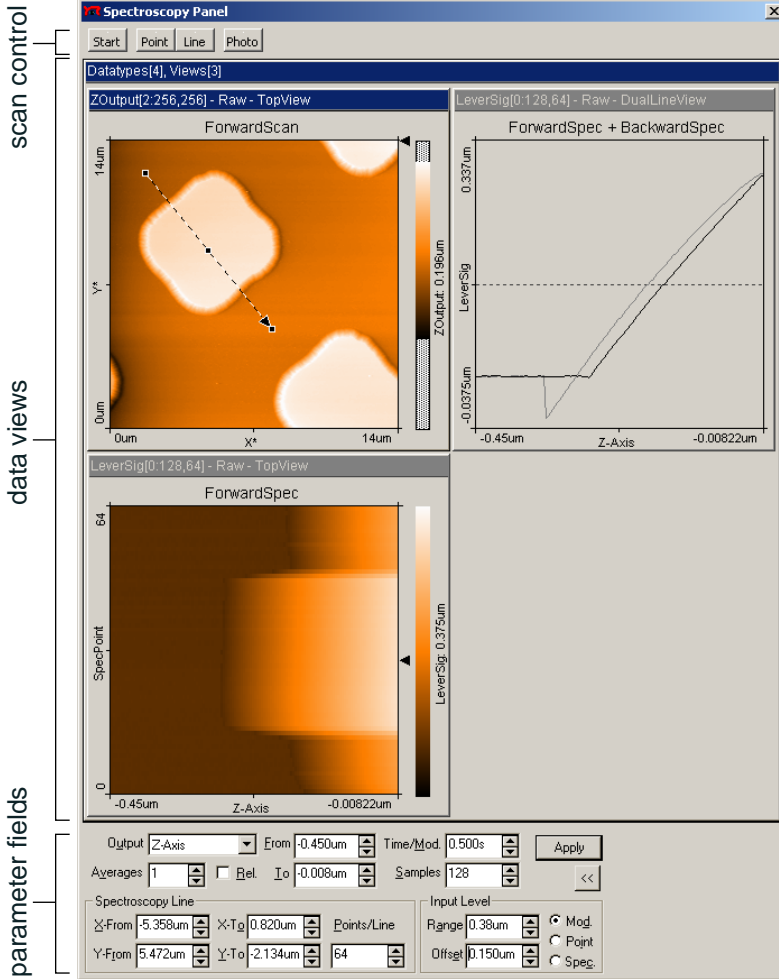





Start/Stop

Start starts a measurement and then changes to **Stop**. This is button can then used to abort the measurement immediately.

Point/Line

The points where a spectrum is to be taken are defined using the mouse after clicking **Point** or **Line**.

If a 'TopView' window is selected a point (click ) or line (click ) can be drawn using the mouse pointer. Clicking only once with the right mouse button generates a small square (point) or arrow (line) pointing to the centre of the view.

After selecting , mark the From and To coordinates by drawing an arrow with the mouse. These coordinates are transferred to the appropriate fields in the lower part of the 'Spectroscopy Panel' by double clicking the left mouse button, or by clicking  in the 'Tool info Panel'.

Click with the right mouse button to abort the function.

Photo

 generates a copy of the measurement document (image and data) which now also contains spectroscopic data, i.e. besides 'ForwardScan' and 'BackwardScan', also 'ForwardSpec' and 'BackwardSpec' appear as 'DataType' in 'View Panel'.

Parameters

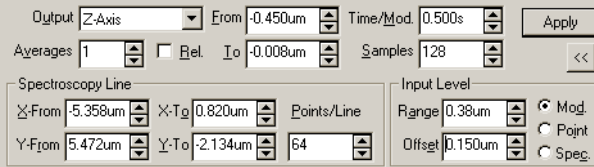

If only some of the parameter fields are visible, the 'Spectroscopy Panel' can be extended using .

Output: Sets the modulated output to be either 'TipVoltage....' or 'Z-Axis'. This output is modulated according to the configuration of the spectroscopy measurement.

Averages: Sets the number of times the modulation is repeated to obtain one averaged spectroscopic measurement.

Rel. If this check box is selected, the 'Output' is varied relative to the actual value of 'TipVoltage' or 'Z-Axis'. If the 'Z-Axis' is modulated, the measurement z-po-

sition is relative to the sample surface when 'Rel.' is selected. The measurement z-position is relative to the xy-plane when 'Rel' is not selected.

From/To: Sets the range between which the modulation 'Output' varies. The 'Forward Spec' measurement starts at the 'From' value and ends at the 'To' value, the 'Backward Spec' does the opposite. The 'Forward Spec' is always measured before the 'Backward Spec'

Time/Mod.: Sets the duration of a single spectroscopy measurement. Within this time the 'Output' is varied between 'From' and 'To'.

Samples: Sets the number of measurement points in one spectroscopic measurement. The measurement positions are equally distributed over the modulation range.

Advanced parameters

Spectroscopy Line:

The following parameters are used to define a spectroscopic measurement sequence:

X-From/Y-From: Sets the xy-coordinates of the measured point in a **Point**-spectroscopy measurement. Sets the xy-coordinates of the starting point of the line in a **Line**-spectroscopy measurement sequence.

X-To/Y-To: Sets the xy-coordinates of the endpoint of the line in a **Line**-spectroscopy measurement sequence. These coordinates are indicated by the arrow.

Points/Line: Sets the number of points at which spectroscopic measurements are to be measured in a **Line**-spectroscopy measurement sequence. The measurement positions are equally distributed over the line.

Input Level:

The settings of 'Input Level' have two functions. First they have the same function as 'Z-Range/InputRange' in the 'Scan Panel'. Additionally these settings are used to limit the safe range of the measured values. If the measured parameter surpasses this range, the measurement is aborted to prevent damage to the tip.

Range: Sets the maximum range of the measured input channel.

Offset: Sets the centre level of the range.

Mod./Point/Spec.: determines what is to be done if the range is surpassed and the measurement aborted:

- 'Mod' - aborts the current modulation period, and continues with the next modulation until the number of modulations in 'Averages' is reached.
- 'Point' - aborts the spectroscopy measurement for the current point and continues with the next point of the line, if a spectroscopy is being performed.
- 'Spec.' - aborts the entire spectroscopy measurement sequence (cancels all 'Averages' and points).

When a spectroscopy measurement has been aborted, a warning sign  is displayed in the 'Spectroscopy Panel'. The number of aborts that occurred in a measurement is reported in 'Data Info Panel' as: ModAborted=<number of aborts>.

Data Info Panel

'Data Info Panel' displays the parameters of the active measurement document. This panel contains a list of the measurement parameters.

TOOL INFO PANEL

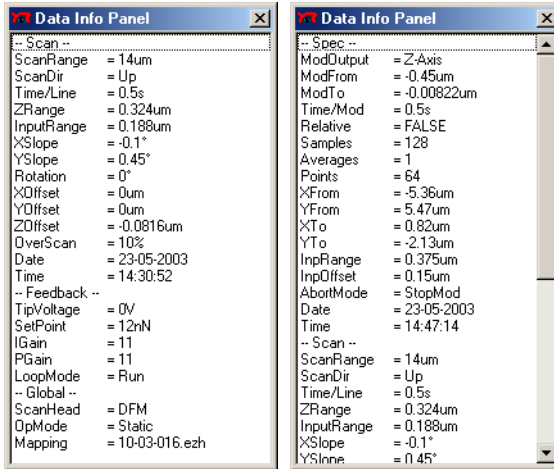

Left: the parameters of a measurement, as shown in the 'Data Info Panel'. Right: the parameters of a spectroscopic measurement are added to the parameter list.

Tool Info Panel

The 'Tool Info Panel' monitors the xyz-mouse coordinates in the scan-coordinate system and the results of the function which is being performed.

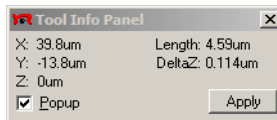

If 'Popup' is activated the Tool Info Panel is only visible while a function is performed which needs the coordinates displayed (e.g. zoom).

Clicking carries out the function of the current tool. This has the same effect as double clicking into the view in which the tool is used.

Result Panel

The 'Result Panel' displays calculated values generated by a tool. The displayed information can be stored in the 'data info' part of the corresponding measurement by clicking .

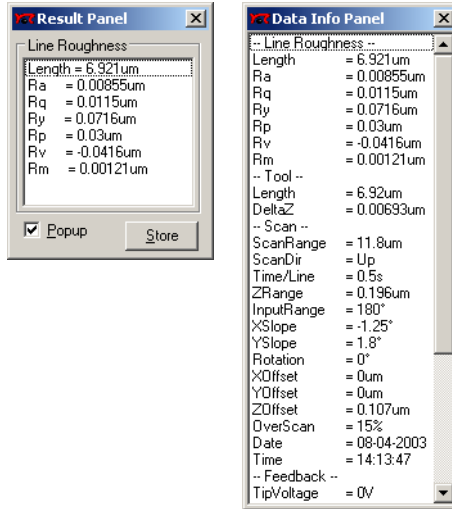

When 'PopUp' is activated, the 'Result Panel' is only visible while a function is being performed that needs its results displayed.

Menu Tools

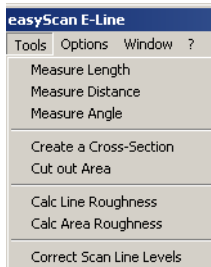



Properties of the measurements can be evaluated numerically using the tools. The tools are activated via the corresponding menu item or by clicking the respective button in the tool bar. Tools can be used in all views, both during measurement and off-line.

Important!

All these results are calculated after the 'LineMath' has been applied to the data. The results will generally vary when a different 'LineMath' option is used.

Measure Length

Using the 'Measure Length' tool  you can define two points. The distance between them is shown in the 'Tool Info Panel'.

- Activate the image to be analysed by clicking onto it with the mouse and then click  or select the menu entry respectively.
- A double ended arrow can be drawn on the data display by holding down left mouse button and dragging the mouse. The length of the arrow is shown in 'Tool Info Panel'.

The arrow can be adjusted by using the markings at each end and moved with the middle point. Clicking without dragging generates an arrow from the current position of the mouse pointer to the centre of the image.

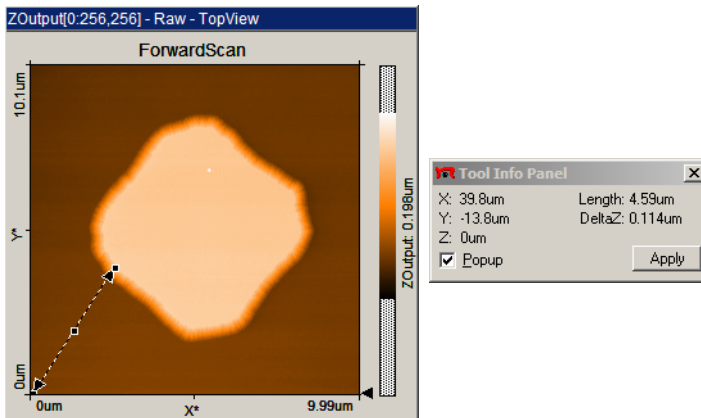

The length measurement is aborted using the right mouse button or by clicking  a second time.

Measure Distance

Using the 'Measure Distance' tool  you can define two parallel lines. The distance between them is shown in the 'Tool Info Panel'.

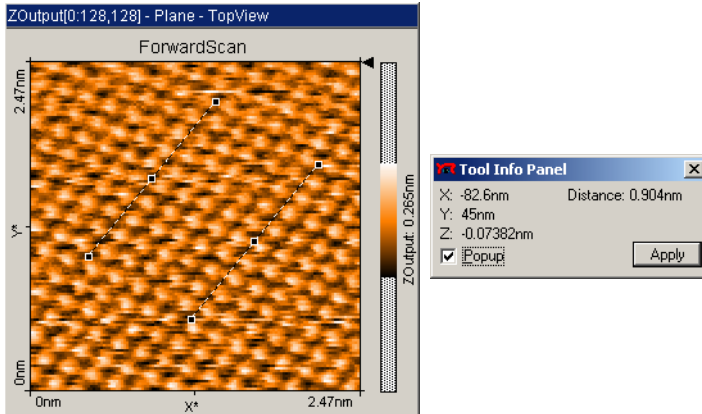

- Activate the image to be analysed by clicking onto it with the mouse and then click  or select the menu entry respectively.
- A line can be drawn into the data display by holding down left mouse button dragging with the mouse.
- After releasing the left mouse button a second parallel line sticks to the mouse pointer and is ready to be positioned. The distance between the two parallel lines is shown in the 'Tool Info Panel'.
- The second parallel line is released by clicking the left mouse button. The angle of both parallel lines can be adjusted by dragging their end points. The lines are translated by dragging their centre.

The distance measurement is aborted by the right mouse button or clicking  a second time.

Measure Angle

Using the 'Measure Angle' tool  you can draw an angle which is to be analysed. The size of the angle drawn is shown in the 'Tool Info Panel'. This tool can only be used in a 'LineView'-type display when it displays height ('ZOutput') data.

- Activate the image to be analysed by clicking into it with the mouse and clicking  or selecting the menu entry respectively.
- An angle can be drawn onto the active data display by clicking and dragging with the mouse pointer. The corresponding size and position of the angle is shown in the 'Tool Info Panel'.

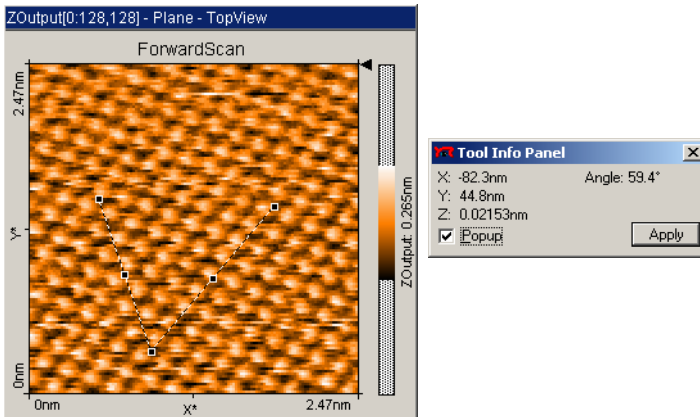



Both sides can be adjusted using the markings. The entire object can be moved using the middle points.

The angle measurement is aborted by using the right mouse button or by clicking  a second time.

Create a Cross-Section

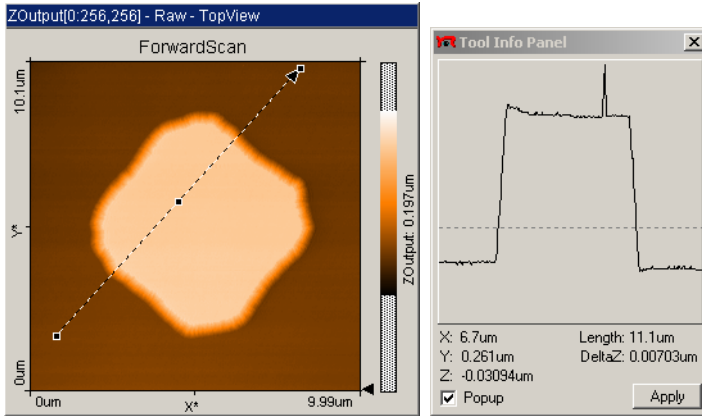

The 'Create a Cross-Section' tool  enables you to view any cross-section of the 'TopView'. This cross section is shown simultaneously in the 'Tool Info Panel' and can be stored in a new measurement document (Data Type: 'CrossSection').



- Activate the image to be analysed by clicking into it with the mouse and click  or select the menu entry respectively.
- Define a line with the  tool, by clicking and dragging while holding down the left mouse button. The arrow tip at the end of the cross-section indicates the direction of the cross-section.

The arrow can be modified in position, size and orientation after releasing left mouse button.

The 'Tool Info Panel' show a view of the cross section and the values of 'DeltaZ' and the length of the section simultaneously. These values are also shown in the 'Data Info Panel'.

A double click of the left mouse button in the 'TopView' window, or clicking  in the tool info panel, stores the cross-section in a separate measurement document. The right mouse button or clicking  cancels this action.

Cut Out Area

The 'Cut Out Area' tool  enables you to create a new measurement document containing a subsection of an existing measurement. The area of the subsection is defined by dragging the mouse pointer over an area in a 'TopView' display while holding down the left mouse button. Once an area is defined, it can be resized by dragging one of its corners, and

CALC LINE ROUGHNESS

moved to the desired position by dragging its centre point. The 'Tool Info Panel' shows the size and position of this new area and the cursor. A double click with left mouse button in the view, or clicking in the tool info panel, generates a new measurement document containing the subsection. The 'Cut Out Area' tool can be aborted by clicking with the right mouse button.

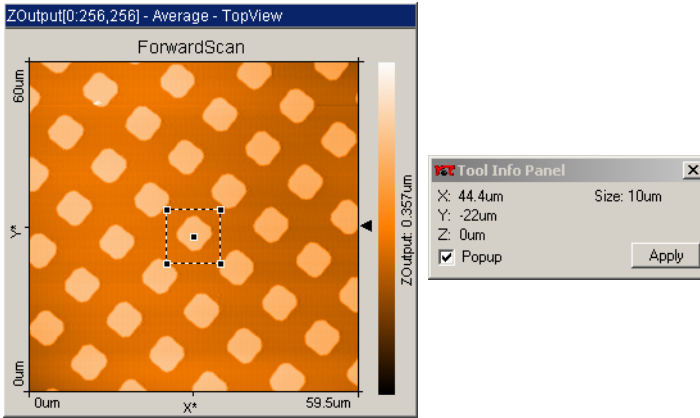

If just a single mouse click is performed in the active 'View', a square 33% of the full area is generated.

Calc Line Roughness

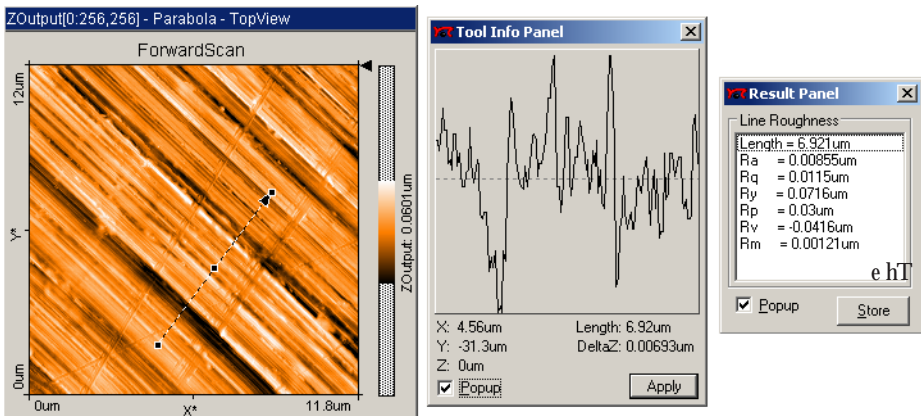

‘Calc Line Roughness’ tool R_a^- allows you to calculate certain roughness parameters of the cross-section that is displayed in the ‘Tool Info Panel’. The calculated values are displayed in the ‘Result Panel’. The cross-section is selected as with the ‘Cross-Section’ tool.

Calc Area Roughness

The ‘Calc Area Roughness’ tool R_a^a allows you to calculate the roughness of a selected area. The size of the area is shown in the ‘Tool Info Panel’ and the actual calculated value is shown in the ‘Result Panel’. The area is selected as with the ‘Cut Out Area’ tool.

The value displayed in result panel are defined as follows:

<p>The Roughness Average, S_a</p> $S_a = \frac{1}{MN} \sum_{k=0}^{M-1} \sum_{l=0}^{N-1} z(x_k, y_l) $	<p>The Mean Value, S_m</p> $S_m = \frac{1}{MN} \sum_{k=0}^{M-1} \sum_{l=0}^{N-1} z(x_k, y_l)$	<p>The Root Mean Square, S_q</p> $S_q = \sqrt{\frac{1}{MN} \sum_{k=0}^{M-1} \sum_{l=0}^{N-1} (z(x_k, y_l))^2}$
<p>The Vally depth, S_v $S_v = \text{lowest value}$</p>	<p>The Peak Height, S_p $S_p = \text{highest value}$</p>	<p>The Peak-Valley Height, S_y $S_y = S_p - S_v$</p>

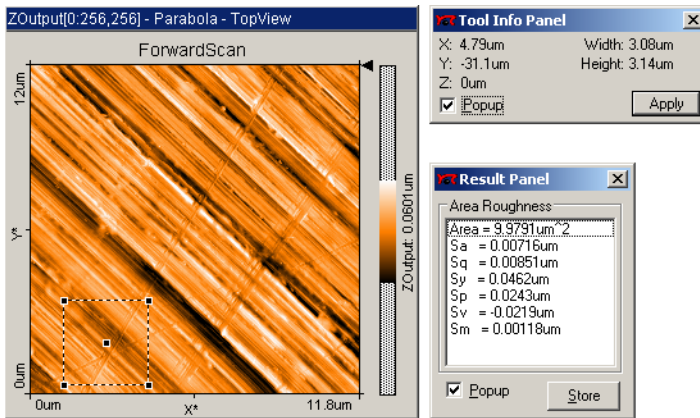

CORRECT SCAN LINE LEVELS

Use the  tool to determine the mean height difference between two plateaus with more accuracy than you can do it with the 'Measure Distance' tool. To determine the mean height difference, select an area on each plateau, and calculate the difference between their Sm-values.

Correct scan line levels

This tool can be used to flatten the image correctly when the 'average' and 'plane' LineMath options do not give satisfactory results. This may occur when the scan lines in different parts of the measurement have a different average height. An example of such a measurement is shown in figure *Correct scan line levels*. To use the tool, draw a line through points that should have the same height. After clicking , the average level of each scan line is adjusted so that all points along the drawn line have the same height. To get useful results, the LineMath option for the display in which you draw the line should generally be 'Raw'.

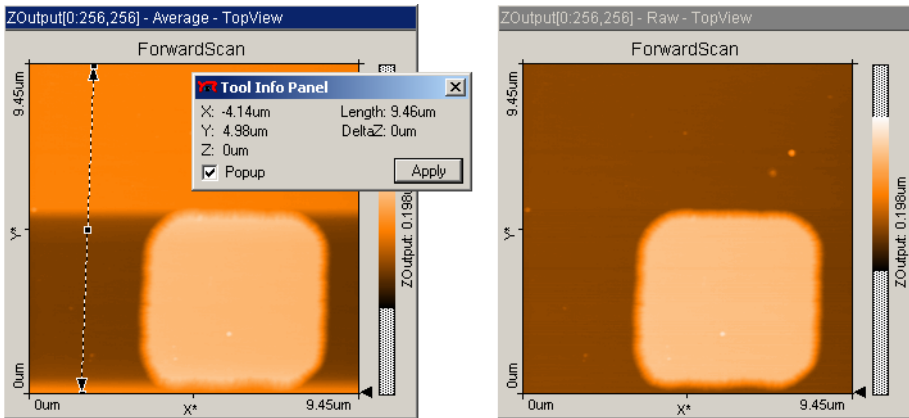

Correct scan line levels, left: uncorrected image with a line through points that should be at the same height, right: corrected image

Optical microscope controls (E-AFM)

Controls for the video option are located in the toolbar:





The video option displays the image of the optical microscope built into the E-AFM.

The video switch buttons

The active video switch button can be either  or .

The video switch buttons are used to set the video channel displayed on the optional video monitor which is used to observe the sensor through the magnifying lenses on the E-AFM scanner.

-  - the video display is switched to the top view channel .
-  - the video display is switched to the side view channel.

Menu Options

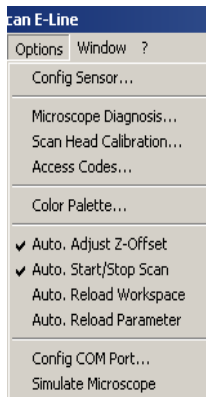

The options menu is used to configure the measurement system. Here the operation mode, calibration, colour palette, various automation procedures and the scanner simulation mode can be set.

Config Sensor... (E-AFM)

The cantilever spring constant of the currently used sensor must be entered in the sensor configuration dialog. The software needs the force constant when performing static mode measurements in order to calibrate the force 'SetPoint' in the 'Feedback Panel'. The spring (or force) constant is supplied with the cantilever (see the label on the cantilever package).

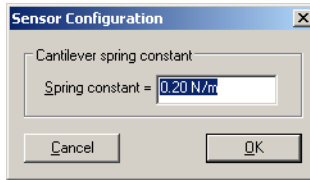

Microscope Diagnosis... (E-AFM)

The system reports the current status information of the sensor and the approach platform. If the 'Sensor Fail' LED on the E-AFM Drive electronics is active then more detailed information about the failure is displayed in the 'Microscope Diagnosis' dialog.

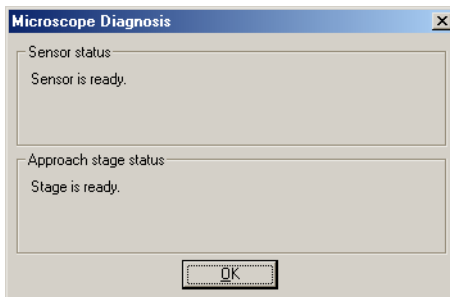

Scan Head Calibration...

In this window the units of all Inputs and Outputs can be configured individually along with the feedback loop properties which can be loaded to the scan-head.

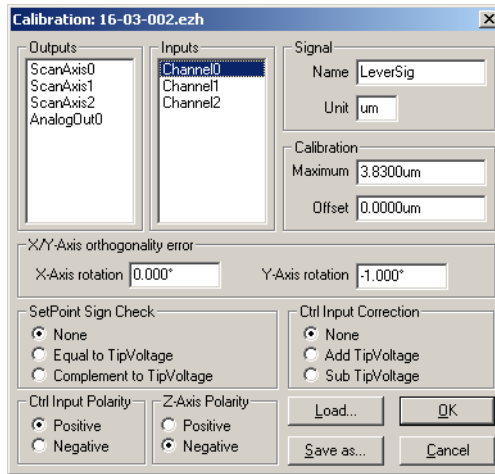

Warning!

Changes to these settings should be performed with great care. False settings can lead to false interpretation of the data and false operation of the controller.

Outputs/Inputs/Signal

On the right half of the window the available signals are listed. In the field 'Signal', a 'Name' and a 'Unit' is assigned to each Input and Output. These names along with their units are used by the program whenever the signals are displayed.

The output for applying a voltage to the tip is called 'TipVoltage' with the E-AFM, and 'GapVoltage' with the E-STM. In the following most of the settings referring to this voltage are used for STM. Therefore the expression 'GapVoltage' is used, but this can also mean 'TipVoltage' for E-AFM users.

Calibration

The 'Calibration' values indicate the maximum input and output range of the respective parameters and are used to calibrate the respective inputs and outputs. 'Maximum' is set for the positive range of the value, e.g. for a scan range of $0.5 \mu\text{m}$ a 'Maximum' value of $0.25 \mu\text{m}$ ($+0.25 \mu\text{m}$, $-0.25 \mu\text{m}$) must be set. 'Offset' is the difference in value relative to zero.

In the lower half of the window are the settings which enable the controller's setting to be adopted so that the measurement system can be used with different scan-heads.

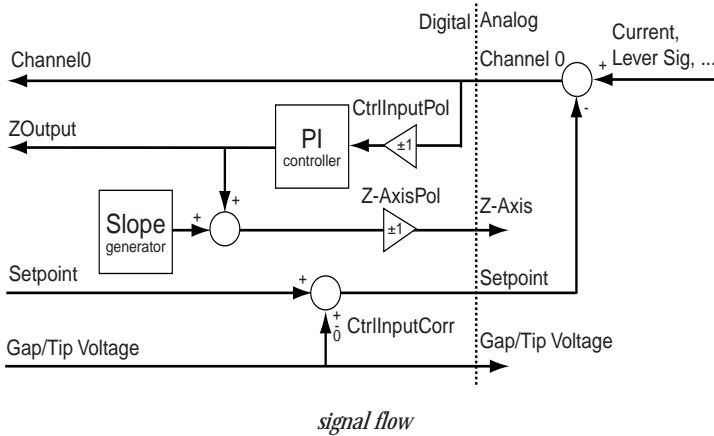

X/Y-axis orthogonality error

If the orthogonality of the scanner is not absolutely perfect, it can be corrected by entering the appropriate angle for 'X-Axis rotation' and 'Y-Axis rotation'. The scan axis coordinate system is rotated clockwise. The figure *signal flow* shows where the settings take effect.

SetPoint Sign Check

The sign (+/-) of the 'SetPoint' is adjusted to the sign (+/-) of 'GapVoltage':

none: 'SetPoint' and 'TipVoltage' have independent signs.

Equal to GapVoltage: 'SetPoint' adopts the sign of 'GapVoltage'.

Complement to GapVoltage: 'SetPoint' adopts the opposite polarity to the 'GapVoltage'.

CtrlInput correction

Before the input signal is measured the voltage 'AnalogOut0', or 'TipVoltage', is mixed with the input signal.

- none:** the voltage from the scan head's preamplifier is not changed.
- Add GapVoltage:** 'AnalogOut0' is added to the output voltage of the scan-head's preamplifier.
- Sub GapVoltage:** 'AnalogOut0' is subtracted from the output voltage of the scan-head's preamplifier.

CtrlInput pol.

Before the measured signal is passed to the PI-controller it can be inverted. Whether this is necessary depends on the type of scan-head.

- positive:** the signal remains unchanged.
- negative:** the signal is inverted.

Z-Axis polarity

The output of the feedback loop can be inverted after the alignment of the scan plane and output to the 'ScanAxis2' (with the STM/AFM Z-axis).

- positive:** the signal remains unchanged.
- negative:** the signal is inverted.

Load

A new set of parameters can be loaded from a scanner calibration file. The default file is 'uncal.ezh'. After loading the new calibration will be used after leaving the dialog.

Important!

Always use the proper calibration file which corresponds to the scanner serial number (e.g. 10-02-007.ezh)

Save As...

The current calibration can be saved in a file.

Access codes...

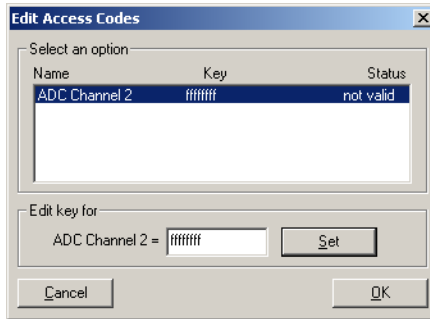

The scan electronics is upgradable with a second channel input. This input option must be activated using a software key, which is supplied on purchase of the 2nd Channel Option.

Enter your access code into the field 'Edit key for'. Confirm the input with the 'Set' button. The 'status' is now 'valid'.

Note: when the software is operating in simulation mode, the option is always 'active'

Color palette...

In menu item 'Options->Color palette...' the color palette is displayed. The color palette is used to map the display range of the measured values to a color. 3 different palette types are available:

- **Black&White:** linear grey scale
- **Color:** The color selection uses the HSB-color model where the color (H) is set in ° value. The input is selected by entering a number or by selecting a color in the color bar, using the mouse pointer.
- **LookUpTable:** A user definable palette (with max. 256 color entries) can be selected. Such a palette is an ASCII table containing a RGB color values for each color tone.

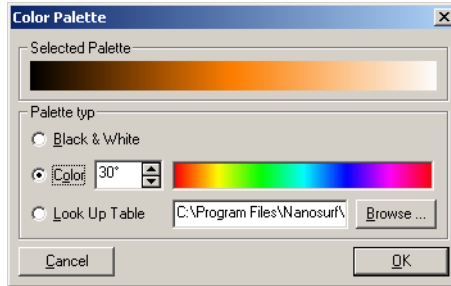

Representation of the color palette

Newly defined palette settings are stored by saving the Workspace's settings.

Auto Adjust Z-Offset

This option is switched on by default. It alters the value of the Z-Offset after each scanned line, so that the signal is always displayed at an optimum range.

Auto Start/Stop Scan

If the menu option 'Auto Start/Stop Scan' is selected, the system automatically starts scanning after approach. Scanning is automatically stopped when the sensor platform is moved using the functions in the 'Approach Panel'.

Auto Reload Workspace

If 'Auto Reload Workspace' is selected, the software reloads the currently used workspace configuration file each time an approach is initiated.

This function is very useful to automatically restore a predefined configuration prior to a new measurement.

Auto Reload Parameter

If 'Auto Reload Parameter' is selected, the software reloads the currently used parameter configuration file each time an approach is initiated.

This function is very useful to automatically restore a predefined configuration prior to a new measurement.

Config COM Port

You can change the number of the RS232 serial interface (COM-port) to which the easyScan electronics is connected. This is useful when you did not configure the COM Port correctly on installation, or changed the COM Port, for example by installing the optional 'USB Adapter: ES'.

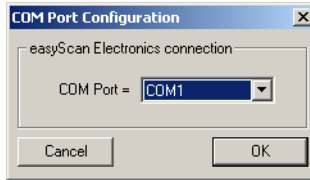

Simulate microscope

Using this item a microscope simulation can be switched on. In the simulation, most functions of the microscope are performed on a mathematically generated surface. Thus, the whole functionality and working methods of the scanning force microscope can be practised. In this case the word 'Simulation' is displayed in the status bar of the program.

When the easyScan software is started without a microscope connected or powered on, the following dialog appears:

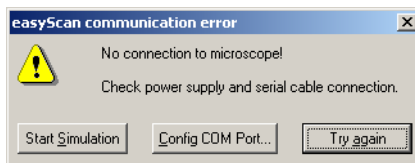

Click **Start Simulation** to automatically turn on the microscope simulation.

Click **Config COM Port...** if the instrument is connected to a different COM Port.

Menu 'Window'

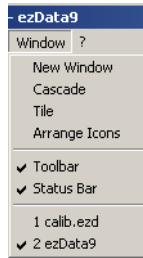

The first section determines the arrangement of the measurement document windows (Cascade, Tile).

The 'Toolbar' and 'Status Bar' can be shown by checking these entries.



The Status bar displays the state of the instrument, whether the microscope simulation is active ('Simulation') or not ('Online'), the active workspace .ezw file, the active parameter .ezs file, active scanner calibration file <serial number>'.ezh' and the instrument type.

The last section of the window menu is a list of all measurement document windows.

Menu '?'

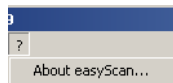

'About easyScan...'

In the 'About...'-window you find the software version as well as the serial number of the connected scan electronics.

‘ABOUT EASYSCAN...’

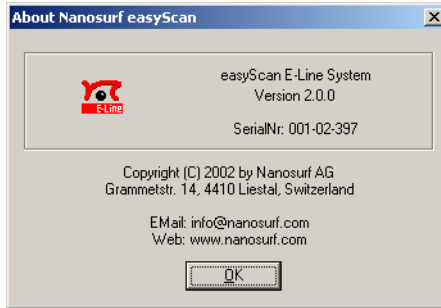

If the microscope simulation is active ‘SerialNr. 000-00-000’ is displayed. The Nanosurf Web-site and contact address for information and software updates are displayed here.

Programs for further data processing

Mountains SPM

The Optional “Mountains SPM” software package offers a powerful and extensive set of analysis functions. Its unmatched reporting capabilities offer the quickest path from measurement to documentation. ‘.ezd’ files can directly be opened via its studiable explorer or the ‘File/Open a studiable...’ menu in version 3.1.7 and newer.

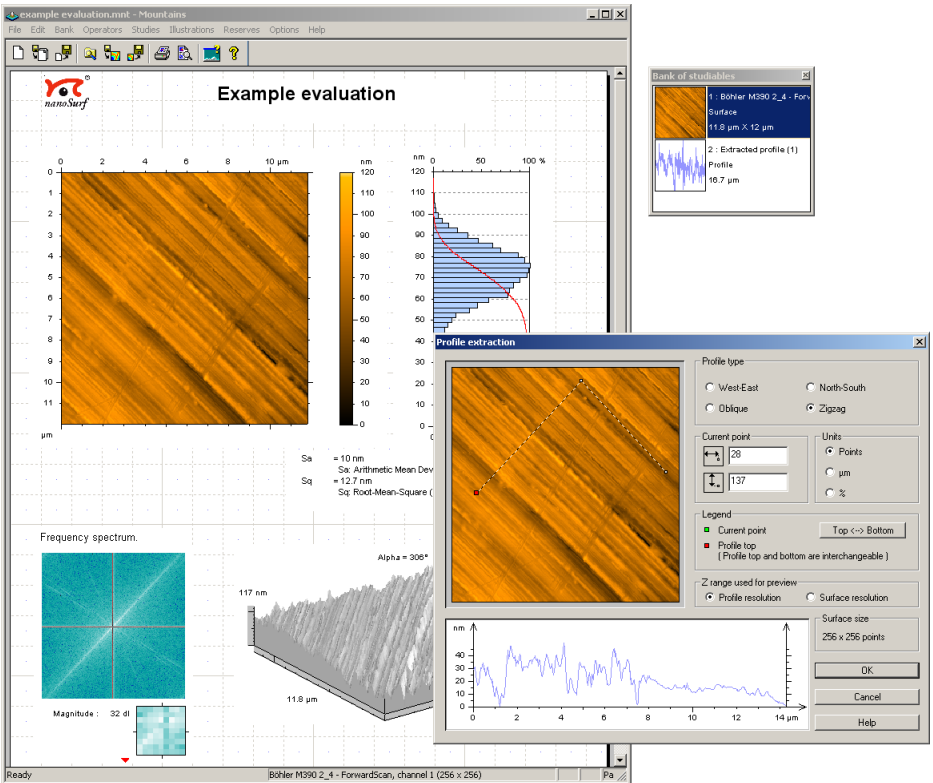

SPIP™

The 'Scanning Probe Image Processor SPIP™' software from Image Metrology (www.imagemet.com) offers SPM specific functions to laboratory users that value powerful analysis more than ease of use.

Freeware

Export measurement data to the freeware using the menu 'File->Export->View as...' and select 'Datafile 8-Bit' as data type .

The following freeware is available in the Internet:

PC: 'Image Tool' source: <http://ddsdx.uthscsa.edu>

Import your data using 'File->Import'. Enter the number of measured points in the field 'ImageSize'. Set 'PixelDepth' to 'Greyscale 8-Bit' and 'Scan Line Padding' to 'Padded to 8 Bit boundaries'.

PC: 'Scion Image' source: <http://www.scioncorp.com>

Import your data using 'File->Import'. Click the 'Set...' button in the 'Import'-dialog, and enter the number of measured points. Set the data type to 'Custom', '8-Bit'.

Mac: 'ImageSXM' source: <http://reg.ssci.liv.ac.uk/>
equivalent to 'Scion Image'

